

foot lamps & identification head

terminals:

connectors: X0 ... X29
 terminal blocks: X50 ... X99
 ext. components and subassembly: X100 ... X199

component identification

ballasts: L
 lamps: E
 control components: A
 fans/motors: M
 switch: S
 capacities: C
 ignitors: Z

canopy lamps 100W: E31-E33, E46-E48
 canopy lamps 80W: E34-E45
 canopy HD-lamps: E50, E51
 base lamps 100W: E1-E30

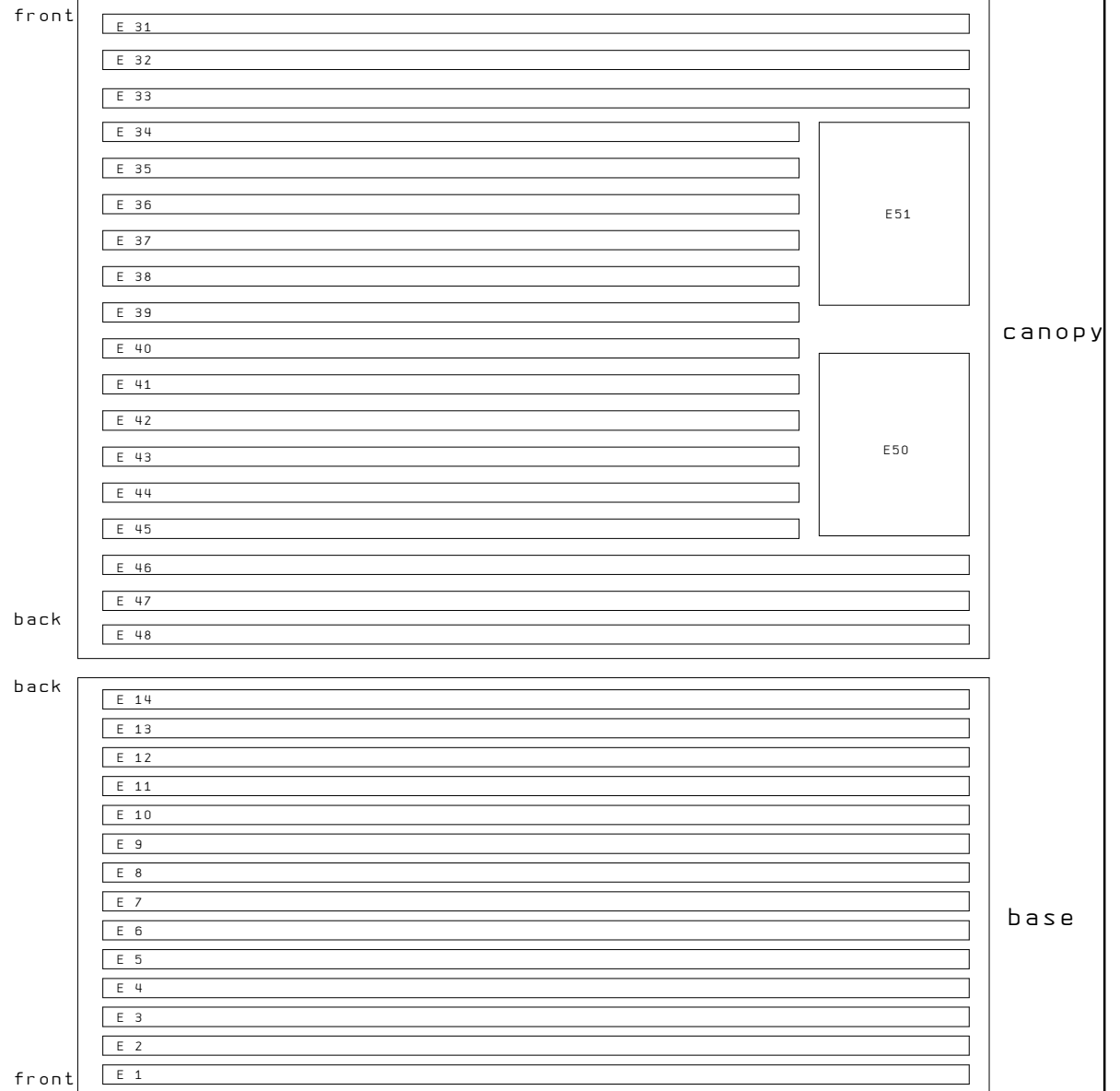

3

5

0		1		2		3		4		5		6		7		8		9	
		date		Typ 7019/70 R GB		lamps & identification		uwe GmbH		drawing-no. A7000/376		ident. -no.:		page		4		9	
		drawn		Tutti Frutti 32 GB USA				Buchstrasse 82 · Postfach 2020		262856		29		pages					
23. Jan. 2003		checked		10. Feb. 2003		origin		repl. for		repl. by		D-73510 Schwäbisch Gmünd		UWE					
modific.		date		name		norm		origin		repl. for		repl. by		UWE					

top view canopy

back

foot

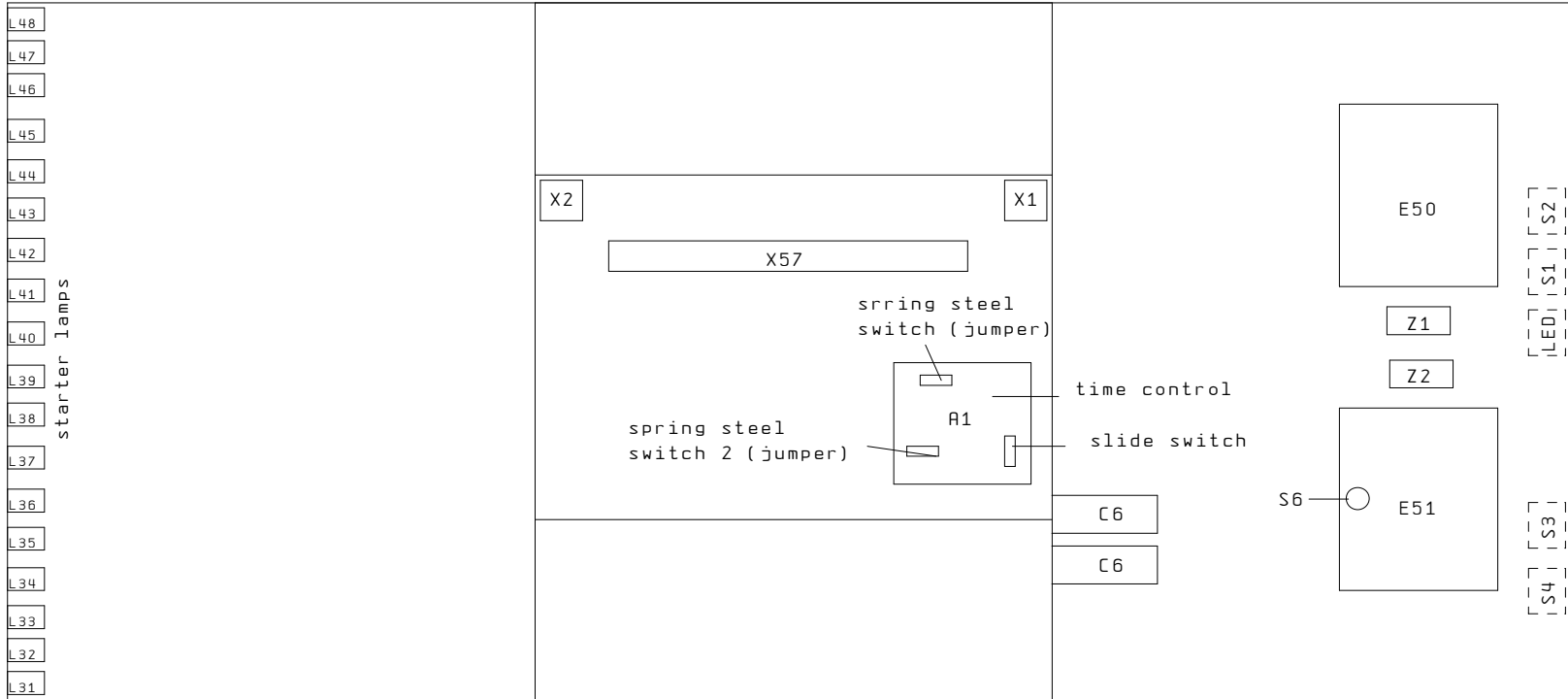

head

front

private-/ coinboxmode

	coinboxmode	privatemode
position spring steel switch 1 (jumper)	snap off	snap in
position spring steel switch 2 (jumper)	snap in	snap off
position slide switch		

4

5a

0	1	2	3	4	5	6	7	8	9
	date drawn 23. Jan. 2003 checked 10. Feb. 2003	Typ 7019/70 R GB Tutti Frutti 32 GB USA		top view canopy		UWE GmbH Buchstrasse 82 · Postfach 2020 D-73510 Schwäbisch Gmünd	drawing-no. A7000/376		
modific.	date	name	norm	origin	repl. for	repl. by	ident. -no. : 262856		page 5 29 pages

UWEFLOR4



constructional features lamp housing base

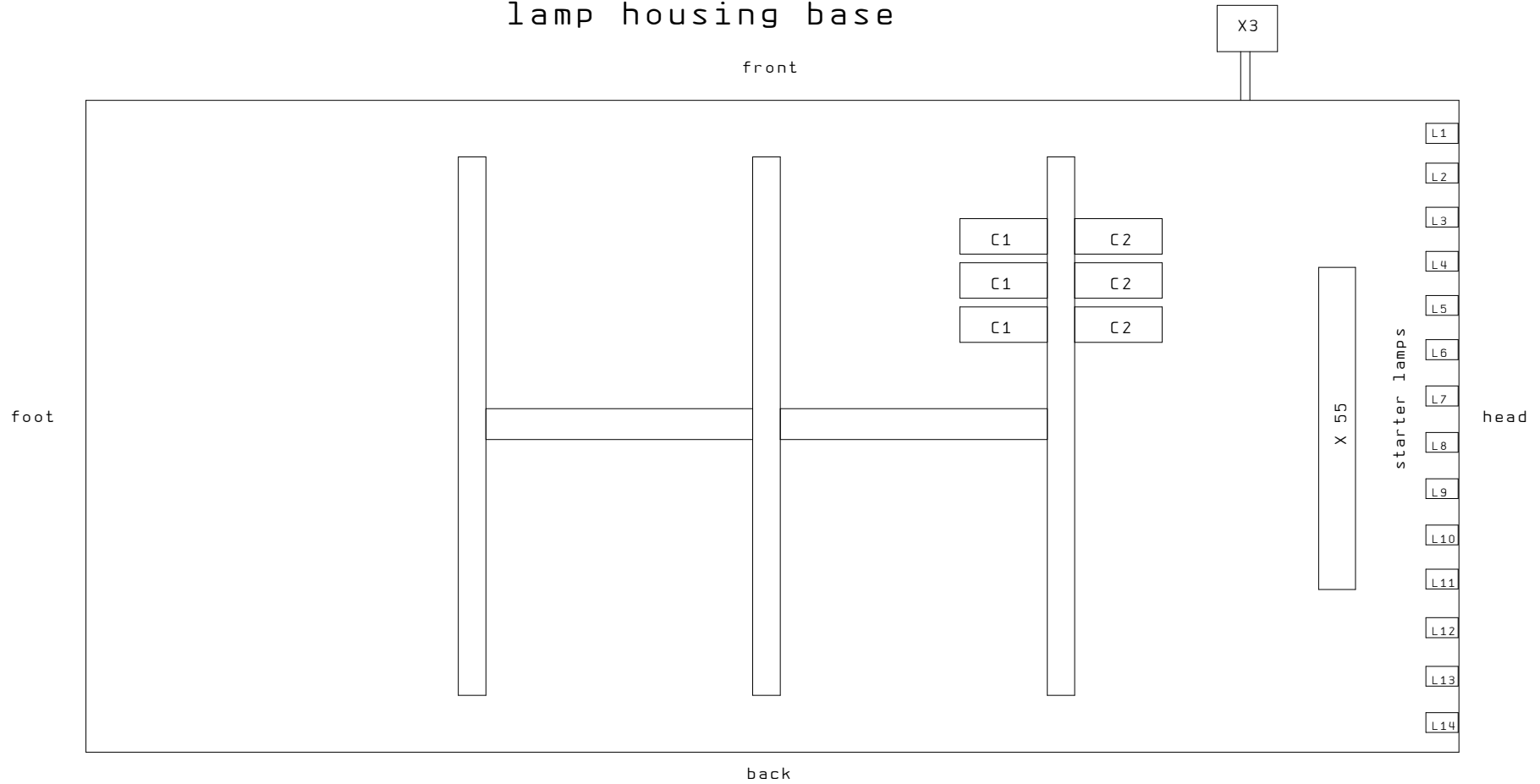

5

5b

0		1		2		3		4		5		6		7		8		9		
		date		Typ 7019/70 R GB		lamp housing								drawing-no. A7000/376				UWEFLOR4		
		drawn		Tutti Frutti 32 GB USA		base								ident. -no. :				page 5a		
23. Jan. 2003		checked												262856				29 pages		
modific.	date	name	norm	origin	repl. for	repl. by														

UWE GmbH
Buchstrasse 82 · Postfach 2020
D-73510 Schwäbisch Gmünd



constructional featres pedestal top view

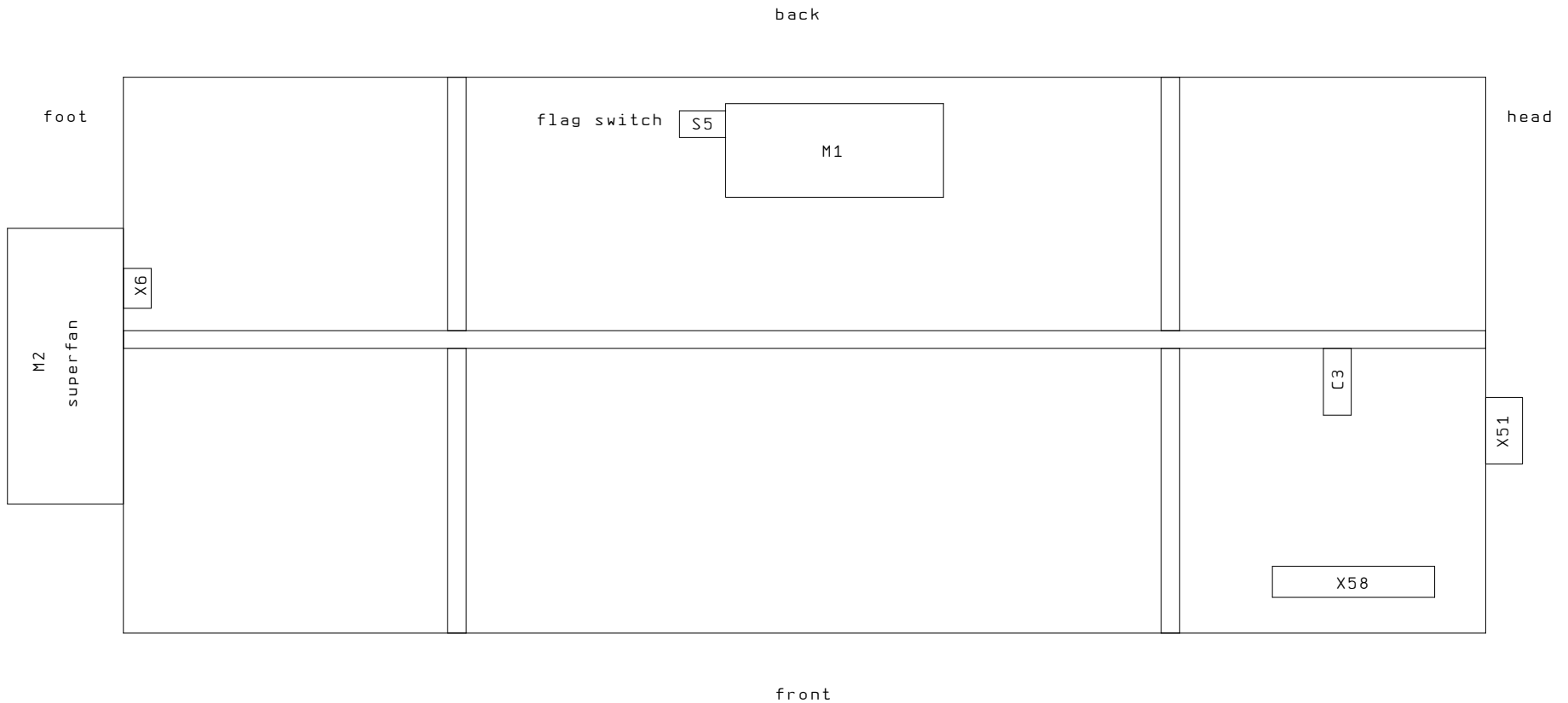

5a

5c

0	1	2	3	4	5	6	7	8	9
	date	Typ 7019/70 R GB		pedestal			drawing-no. A7000/376		UWEPL0R4
	drawn	Tutti Frutti 32 GB USA							
	checked								
23. Jan. 2003	10. Feb. 2003								page 5b
modific.	date	name	norm	origin	repl. for	repl. by	ident. -no. : 262856		29 pages

uwe GmbH
 Buchstrasse 82 · Postfach 2020
 D-73510 Schwäbisch Gmünd



control panels

headside canopy

canopy front

back

foot

head

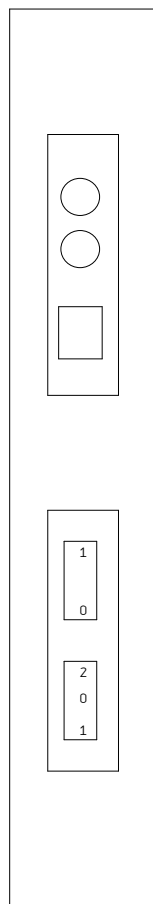

stop
start
LED

switch E40/E41
switch superfan

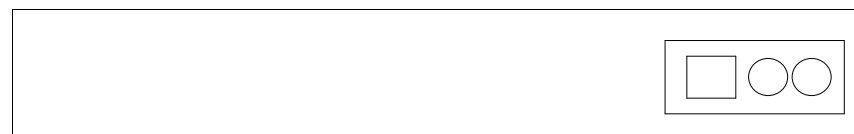

LED
start
stop

5d

6

0		1		2		3		4		5		6		7		8		9		
		date		Typ 7019/70 R GB		control						drawing-no. A7000/376						UWEPL0R4		
		drawn	MAD	Tutti Frutti 32 GB USA		panels				UWE GmbH		ident. -no. :						page 5e		
	23. Jan. 2003	checked	10. Feb. 2003							Buchstrasse 82 · Postfach 2020		262856						29 pages		
modific.	date	name	norm	origin	repl. for	repl. by			D-73510 Schwäbisch Gmünd		UWE									

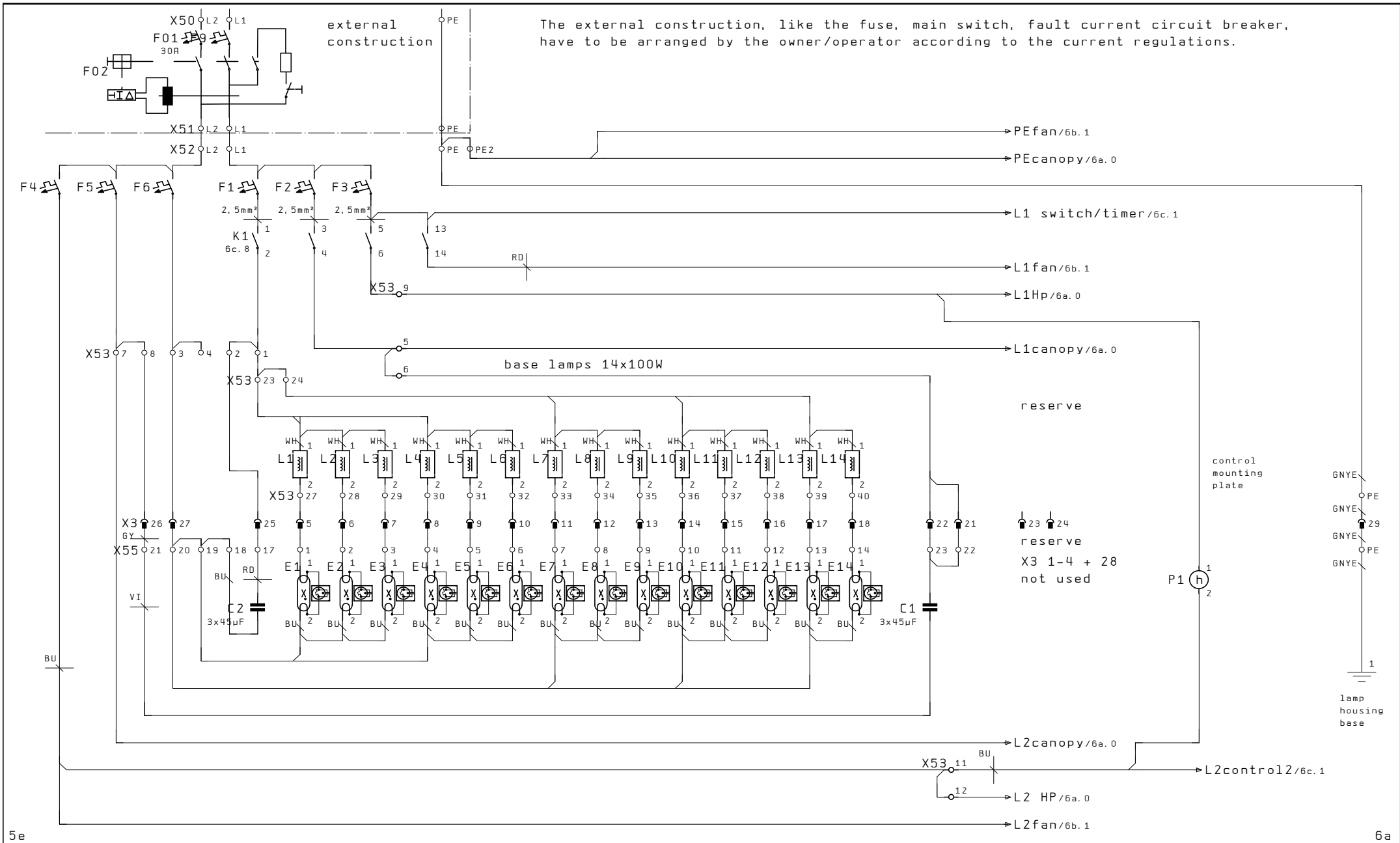

0	1	2	3	4	5	6	7	8	9
	date	Typ 7019/70 R GB		base circuit			drawing-no. A7000/376		UWEPLOR4
	drawn MAD	Tutti Frutti 32 GB USA							
23. Jan. 2003	checked 10. Feb. 2003						ident. -no. : 262856		page 6
modific.	date	name	norm	origin	repl. for	repl. by			29 pages

UWE GmbH
 Buchstrasse 82 · Postfach 2020
 D-73510 Schwäbisch Gmünd



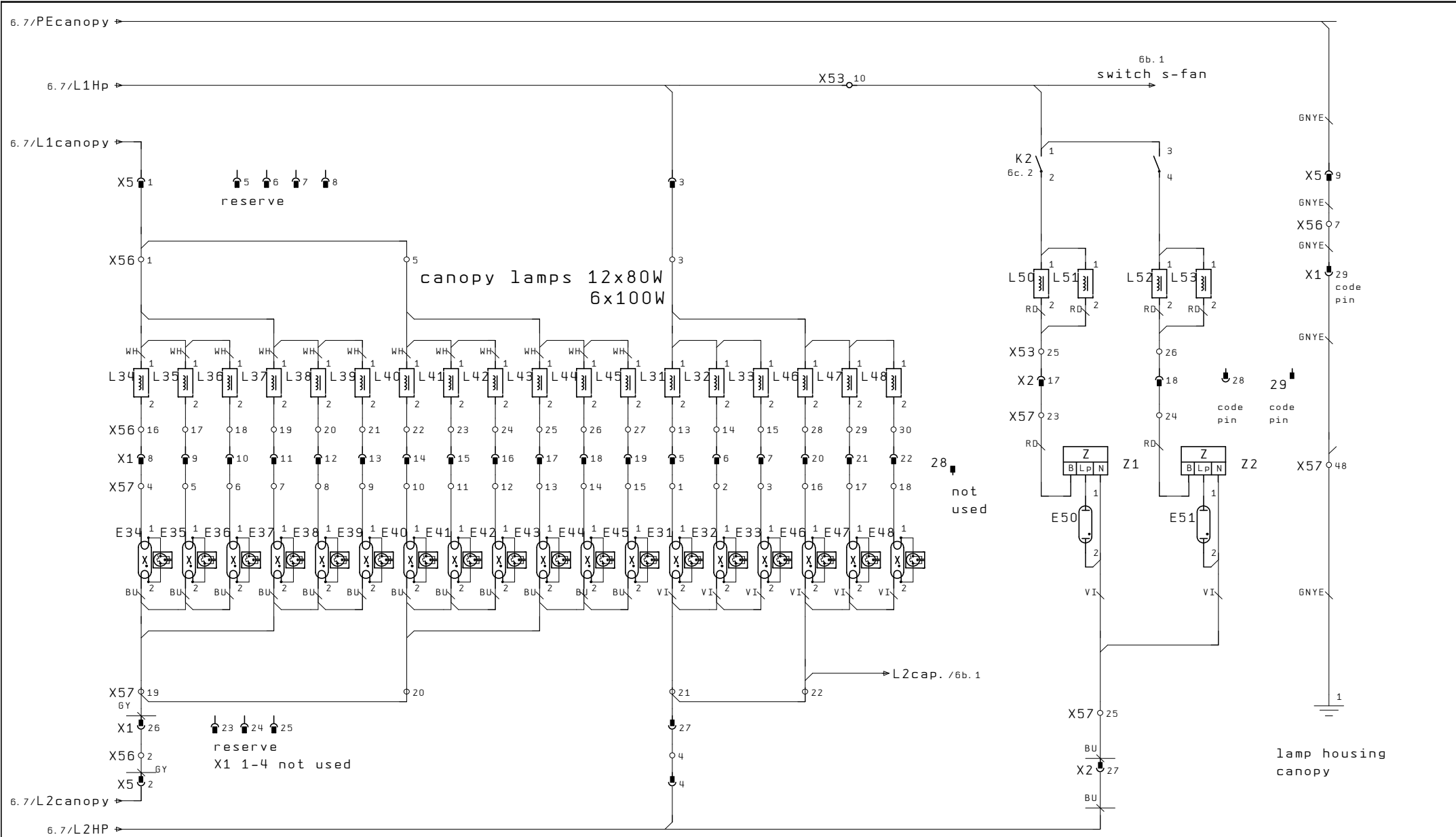

6

6b

0	1	2	3	4	5	6	7	8	9
	date	Typ 7019/70 R GB		canopy			drawing-no. A7000/376		UWEPLOR4
	drawn MAD	Tutti Frutti 32 GB USA		circuit					
23. Jan. 2003	checked 10. Feb. 2003						ident. -no.:		page 6a
modific.	date	name	norm	origin	repl. for	repl. by	262856		29 pages

UWE GmbH
 Buchstrasse 82 · Postfach 2020
 D-73510 Schwäbisch Gmünd



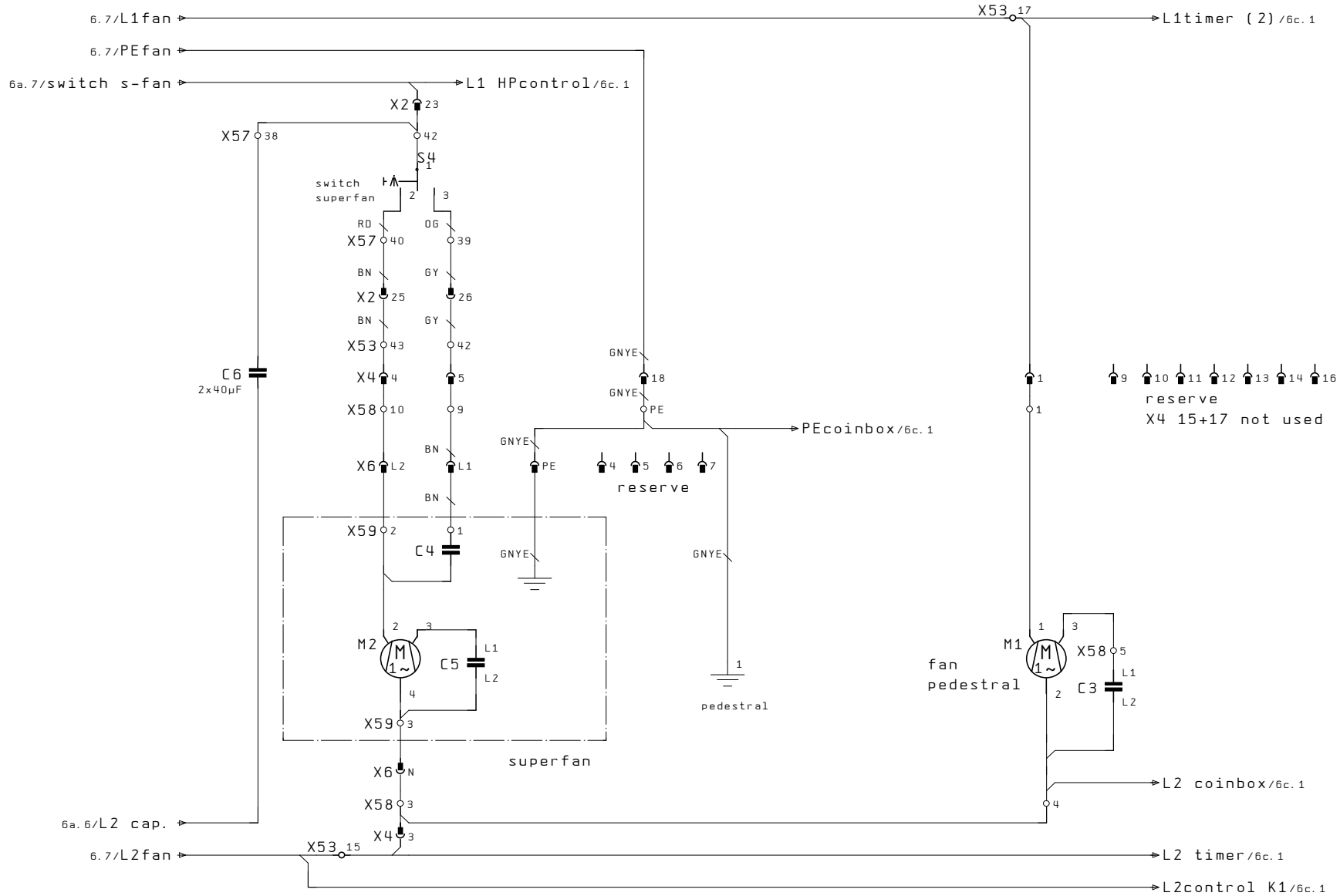

9 10 11 12 13 14 16
 reserve
 X4 15+17 not used

6a

6c

0		1		2		3		4		5		6		7		8		9		
		date		Typ 7019/70 R GB		fan								drawing-no. A7000/376				UWEPLOR4		
		drawn	MAD	Tutti Frutti 32 GB USA		circuit								ident. -no.:				page 6b		
	23. Jan. 2003	checked	10. Feb. 2003											262856				29 pages		
modific.	date	name	norm	origin	repl. for	repl. by														

uwe GmbH
 Buchstrasse 82 · Postfach 2020
 D-73510 Schwäbisch Gmünd



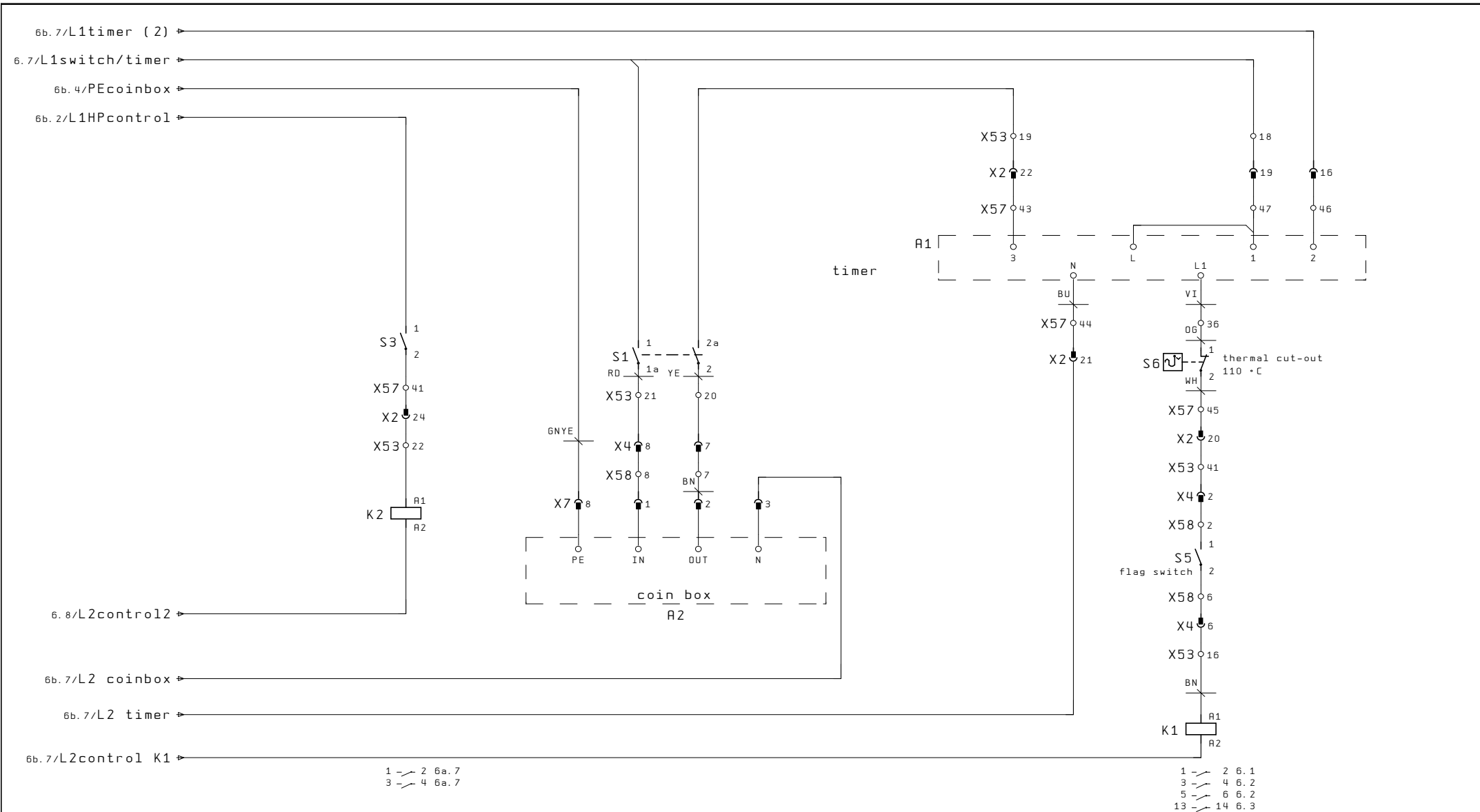

6b

7

0	1	2	3	4	5	6	7	8	9
	date	Typ 7019/70 R GB		control			drawing-no. A7000/376		UWEPLOR4
	drawn MAD	Tutti Frutti 32 GB USA		circuit					
23. Jan. 2003	checked 10. Feb. 2003						ident. -no.:		page 6c
modific.	date	name	norm	origin	repl. for	repl. by	262856		29 pages

UWE GmbH
Buchstrasse 82 · Postfach 2020
D-73510 Schwäbisch Gmünd



terminal diagram

KLEINLENG 03.01.2001

function text	cabelname		identification terminal block X1							cabelname		page/path
	BK	GNYE	connection	finish designation	device connection	bridges	terminal number	connection	finish designation	BK	GNYE	
	X		X57 1	X56 13			5			X		6a.4
	X		X57 2	X56 14			6			X		6a.4
	X		X57 3	X56 15			7			X		6a.5
	X		X57 4	X56 16			8			X		6a.1
	X		X57 5	X56 17			9			X		6a.1
	X		X57 6	X56 18			10			X		6a.1
	X		X57 7	X56 19			11			X		6a.1
	X		X57 8	X56 20			12			X		6a.2
	X		X57 9	X56 21			13			X		6a.2
	X		X57 10	X56 22			14			X		6a.2
	X		X57 11	X56 23			15			X		6a.3
	X		X57 12	X56 24			16			X		6a.3
	X		X57 13	X56 25			17			X		6a.3
	X		X57 14	X56 26			18			X		6a.4
	X		X57 15	X56 27			19			X		6a.4
	X		X57 16	X56 28			20			X		6a.5
	X		X57 17	X56 29			21			X		6a.5
	X		X57 18	X56 30			22			X		6a.6
							23					6a.1
							24					6a.1
							25					6a.1
	X		X56 2	X57 19			26			X		6a.1
	X		X56 4	X57 21			27			X		6a.4
	X		X57 48	X56 7			29				X	6a.9

6c

8

date	11.Okt.2002	Typ 7019/70 R 6B		X1		Uwe GmbH Buchstrasse 82 · Postfach 2020 D-73510 Schwäbisch Gmünd		drawing-no. A7000/376		UWEPL0R4
drawn	VEH	Tutti Frutti 32 6B USA						ident. -no. :		page 7
checked	10.Feb.2003	origin	repl. for	repl. by			262856		pages 29	
modific.	date	name	norm							

terminal diagram

KLEINLENG 03.01.2001

function text	cabelname	cabeltype	BK	GNYE	terminal number	bridges	device connection	finish designation	connection	finish designation	connection	cabelname	cabeltype	BK	GNYE	page/path
			X					X58 1	X53 17					X		6b.6
			X					X58 2	X53 41					X		6c.8
			X					X53 15	X58 3					X		6b.2
			X					X58 10	X53 43					X		6b.2
			X					X58 9	X53 42					X		6b.2
			X					X53 16	X58 6					X		6c.8
			X					X58 7	X53 20					X		6c.4
			X					X58 8	X53 21					X		6c.4
																6b.6
																6b.7
																6b.7
																6b.7
																6b.8
														X		6b.4
								X58 PE	X52 PEZ							

9

11

0	1	2	3	4	5	6	7	8	9
	date	11.Okt.2002	Typ 7019/70 R GB	X4			drawing-no. A7000/376		UWEPLOR4
	drawn	VEH	Tutti Frutti 32 GB USA						
23. Jan. 2003	checked	10. Feb. 2003					ident. -no. :		page 10
modific.	date	name	norm	origin	repl. for	repl. by	262856		29 pages

uwe GmbH
 Buchstrasse 82 · Postfach 2020
 D-73510 Schwäbisch Gmünd



identification terminal block		cabelname		cabeltype		connection		finish designation		device connection		bridges		terminal number		connection		finish designation		cabelname		cabeltype		BK		BU		BN		WH		function text			
X53		X		K1 2		K1						1		X3 25																					
		X										2		X3 27																					
		X										3																							
		X										4																							
		X										5		X5 1																					
		X										6		X3 22																					
		X										7		X3 21																					
		X										8		X5 2																					
		X										9		X3 26																					
		X										10		P1 1																					
		X										11		X5 3																					
		X										12		S3 1																					
		X										13		X2 23																					
		X										14		K2 A2																					
		X										15		P1 2																					
		X										16		X2 27																					
		X										17		X5 4																					
		X										18		X2 21																					
		X										19		X4 3																					
		X										20		K1 A1																					
		X										21		X2 16																					
		X										22		X4 1																					
		X										23		X2 19																					
		X										24		P1 2																					
		X										25		X2 22																					
		X										26		X4 7																					
		X										27		X4 8																					
		X										28		X4 8																					
		X										29		K2 A1																					
		X										30		L4 1																					
		X										31		L13 1																					
		X										32		L7 1																					
		X										33		X2 17																					
		X										34		X2 18																					
		X										35		X3 5																					
		X										36		X3 6																					
		X										37		X3 7																					
		X										38		X3 8																					
		X										39		X3 9																					
		X										40		X3 10																					
		X										41		X3 11																					
		X										42		X3 12																					
		X										43		X3 13																					
		X										44		X3 14																					
		X										45		X3 15																					
		X										46		X3 16																					
		X										47		X3 17																					
		X										48		X3 18																					
		X										49		X3 19																					
		X										50		X3 20																					
		X										51		X4 2																					

0		1		2		3		4		5		6		7		8		9	
date		11.Okt.2002		Typ 7019/70 R 6B		X53		Uwe GmbH		drawing-no. A7000/376		UWEPLOR4		page		15			
drawn		VEH		Tutti Frutti 32 6B USA				Buchstrasse 82 · Postfach 2020		ident. -no. :		262856		page		29			
checked		10.Feb.2003						D-73510 Schwäbisch Gmünd		UWE				pages		29			
modific.		date		name		norm		origin		repl. for		repl. by							

function text	cabelname				identification terminal block X56							cabelname		page/path	
	WH	GY	BK	GNYE	finish designation	connection	terminal number	bridges	device connection	finish designation	connection	cabeltype	GNYE		BK
	X				L34	1	1			X5	1			X	6a.1
		X			L37	1								X	6a.1
			X		X5	2	2			X1	26			X	6a.4
				X	L31	1	3			X5	3			X	6a.4
			X		L46	1								X	6a.4
				X	X5	4	4			X1	27			X	6a.2
				X	L40	1	5								6a.9
			X		L93	1								X	6a.4
	X				X1	29	7			X5	9				6a.4
				X	X1	5	13			L31	2			X	6a.4
				X	X1	6	14			L32	2			X	6a.4
				X	X1	7	15			L33	2			X	6a.5
				X	X1	8	16			L34	2			X	6a.1
				X	X1	9	17			L35	2			X	6a.1
				X	X1	10	18			L36	2			X	6a.1
				X	X1	11	19			L37	2			X	6a.1
				X	X1	12	20			L38	2			X	6a.2
				X	X1	13	21			L39	2			X	6a.2
				X	X1	14	22			L40	2			X	6a.2
				X	X1	15	23			L41	2			X	6a.3
				X	X1	16	24			L42	2			X	6a.3
				X	X1	17	25			L43	2			X	6a.3
				X	X1	18	26			L44	2			X	6a.4
				X	X1	19	27			L45	2			X	6a.4
				X	X1	20	28			L46	2			X	6a.5
				X	X1	21	29			L47	2			X	6a.5
				X	X1	22	30			L48	2			X	6a.6

0	1	2	3	4	5	6	7	8	9
	date	11.Okt.2002	Typ 7019/70 R GB		X56		drawing-no. A7000/376		
	drawn	VEH	Tutti Frutti 32 GB USA		Uwe GmbH		ident. -no. :		
23. Jan. 2003	checked	10. Feb. 2003	origin	repl. for	repl. by	Buchstrasse 82 · Postfach 2020		262856	
modific.	date	name	norm	origin	repl. for	repl. by	D-73510 Schwäbisch Gmünd		page 18
							UWE		29 pages

