

Uwe GmbH
 Buchstrasse 82 · Postfach 2020
 D-73510 Schwäbisch Gmünd



drawing-no. : A7000/466
 device type/ designation : Typ 7019/170 Silverbullet
 commission :

path : 3
 creation date : 14. Dez. 2001
 drawn by : NOS
 modification date : 29. Jul. 2004
 modified by : NOS

feeding in : 3/2~60Hz 220V 40/80A

number of pages : 49

All rights reserved

technical modifications reserved

0		1		2		3		4		5		6		7		8		9	
		date	18. Sep. 2002	Typ 7019/170				cover page						drawing-no. A7000/466					
		drawn	NOS	Silverbullet															
	29. Jul. 2004	checked	11. Aug. 2004																
modific.	date	name	norm	origin	repl. for	repl. by			uwe GmbH Buchstrasse 82 · Postfach 2020 D-73510 Schwäbisch Gmünd				ident. -no. : 267155				page 1 pages 49		

index

WUPJ00100 22.10.00

page	page designation	extra field	date	drawer	X
1	cover page		29. Jul. 2003	NOS	
2	index		29. Jan. 2004	NOS	x
2a	index		29. Jan. 2004	NOS	x
3	modifications		30. Mär. 2004	MAD	
4	lamps, identifikation		28. Mai. 2004	NOS	
5	mounting plate #1 control panel		28. Mai. 2004	NOS	
5a	mounting plate #2 bed		28. Mai. 2004	NOS	
5b	mounting plate #3 HP canopy		28. Mai. 2004	NOS	
5c	mounting plate #4 canopy		28. Mai. 2004	NOS	
5d	pedestral housing		28. Mai. 2004	MAD	
5e	canopy		28. Mai. 2004	NOS	
6	main circuit		28. Mai. 2004	MAD	
6a	base lamps		03. Mai. 2004	MAD	
6b	canopy lamps		27. Mai. 2004	MAD	
6c	canopy lamps		25. Mai. 2004	NOS	
6d	light effects		28. Mai. 2004	NOS	
6e	HP lamps		27. Mai. 2004	MAD	
6f	fan circuit		27. Mai. 2004	NOS	
6g	PE		27. Mai. 2004	NOS	
6h	breeze		18. Mai. 2004	MAD	
6i	safety loop		28. Mai. 2004	NOS	
6j	control circuit		28. Mai. 2004	MAD	
6k	control circuit		28. Mai. 2004	NOS	
6l	audio		28. Mai. 2004	NOS	
7	X1		27. Mai. 2004	NOS	
8	X2		27. Mai. 2004	NOS	
9	X3		27. Mai. 2004	NOS	
10	X4		27. Mai. 2004	NOS	
11	X5		27. Mai. 2004	NOS	
12	X6		27. Mai. 2004	NOS	

1

2a

0		1		2		3		4		5		6		7		8		9	
		Datum		Typ 7019/170		Inhaltsverzeichnis								Z.-Nr.: A7000/466					
		Bearb.	NOS	Silverbullet															
	29. Jul. 2004	Gepr.	11. Aug. 2004																
Anderung	Datum	Name	Norm	Urspr.	Ers. f.	Ers. d.			uwe GmbH Buchstrasse 82 · Postfach 2020 D-73510 Schwäbisch Gmünd				Mat.-Nr.: 267155				Bl. 2 49 Bl.		

terminals:

connectors: X0 ... X29
 terminal blocks: X50 ... X99
 ext. components and subassembly: X100 ... X199

component identification

ballasts: L
 ignition components: Z
 lamps: E
 control components: A
 fans/motors: M
 circuit-breaker: Q
 control switch: S
 timer: P

LP base lamps: E1-E20
 HP and LP lamps canopy: E21-50

background light illumination: E80, E81, E 83-E 85

speedlight E86-E88
 floorlight: E82

color code

color	code
white	WH
red	RD
blue	BU
green	GN
yellow	YE
grey	GY
brown	BN
orange	OG
black	BK
turquoise	TQ
ivory	IV
beige	BE
oliv	OL
violett	VI
green yellow	GNYE

lamps and identification

foot

front

head

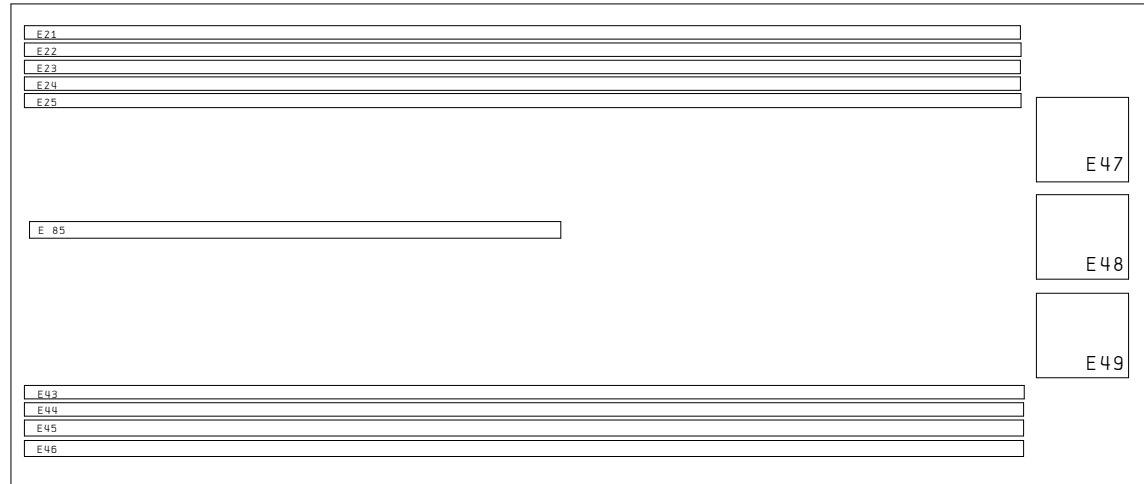

canopy

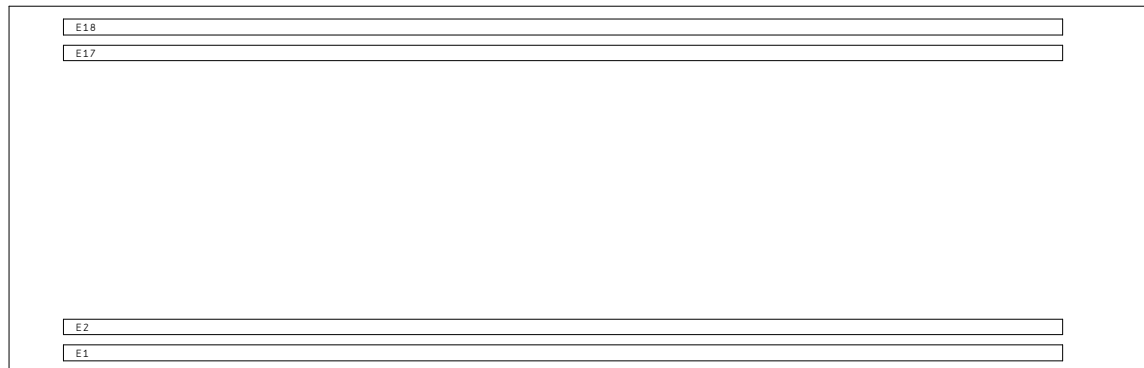

base

front

3

5

0		1		2		3		4		5		6		7		8		9	
		date		Typ 7019/170				lamps,						drawing-no. A7000/466				UWEPLOR4	
		drawn	NOS	Silverbullet				identifikation						ident. -no.:				page 4	
	29. Jul. 2004	checked	11. Aug. 2004											267155				49 pages	
modific.	date	name	norm	origin	repl. for	repl. by													

UWE GmbH
 Buchstrasse 82 · Postfach 2020
 D-73510 Schwäbisch Gmünd



mounting plate no. 1; control panel

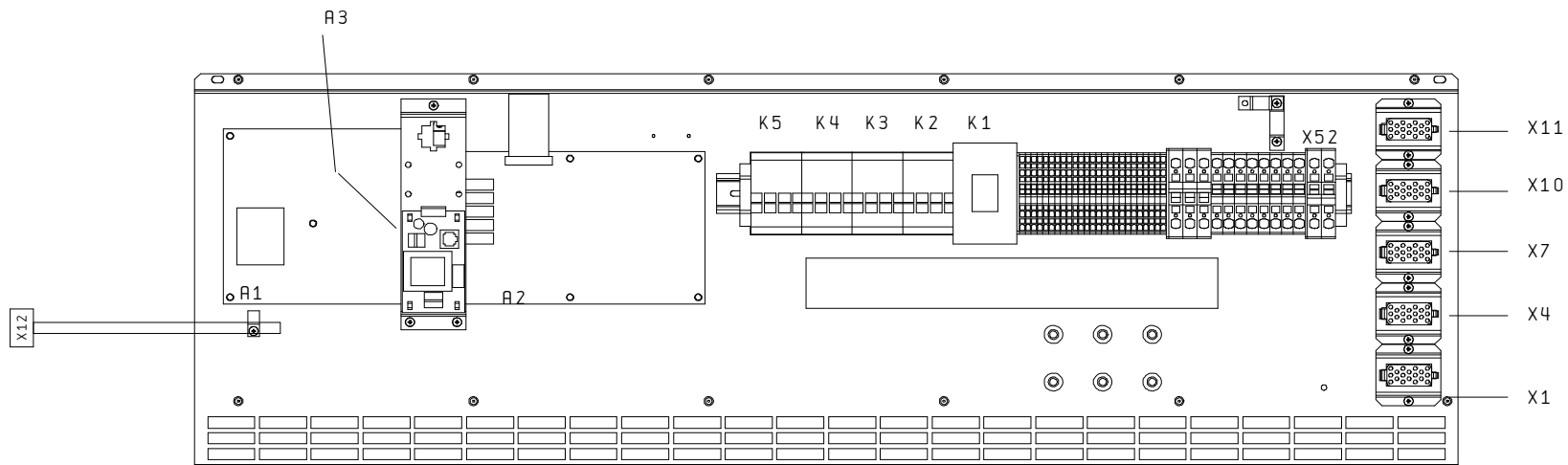
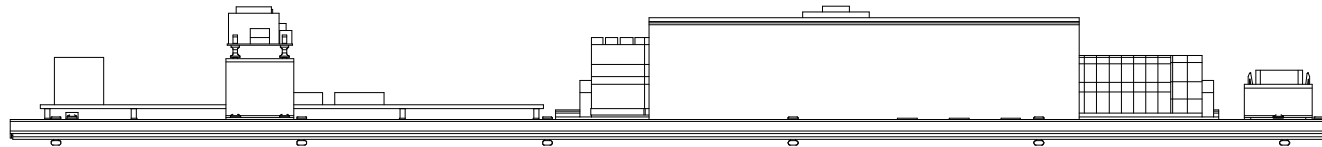

0		1		2		3		4		5		6		7		8		9		
		date		Typ 7019/170				mounting plate #1						drawing-no. A7000/466				UWEPLOR4		
		drawn	NOS	Silverbullet				control panel						ident. -no. :				page 5		
	29. Jul. 2004	checked	11. Aug. 2004											267155				49 pages		
modific.	date	name	norm	origin	repl. for	repl. by														

UWE GmbH
 Buchstrasse 82 · Postfach 2020
 D-73510 Schwäbisch Gmünd



mounting plate no. 2; bed

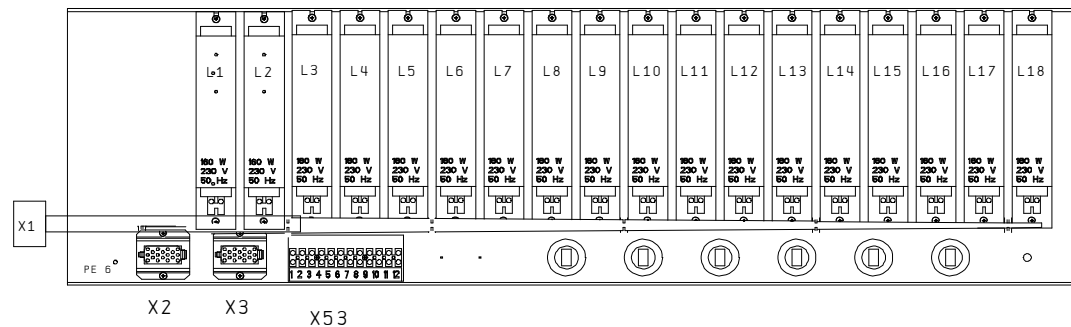
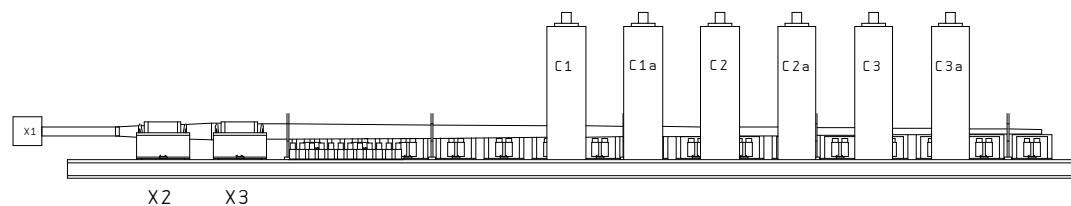

5

5b

0	1	2	3	4	5	6	7	8	9
	date	Typ 7019/170		mounting plate #2 bed	uwe GmbH Buchstrasse 82 · Postfach 2020 D-73510 Schwäbisch Gmünd		drawing-no. A7000/466		UWEPL0R4
	drawn	Silverbullet					ident. -no. :		page 5a
modific.	date	name	norm	origin	repl. for	repl. by	267155	49 pages	
	29. Jul. 2004								
		checked	11. Aug. 2004						

mounting plate no. 3; HP lamps canopy

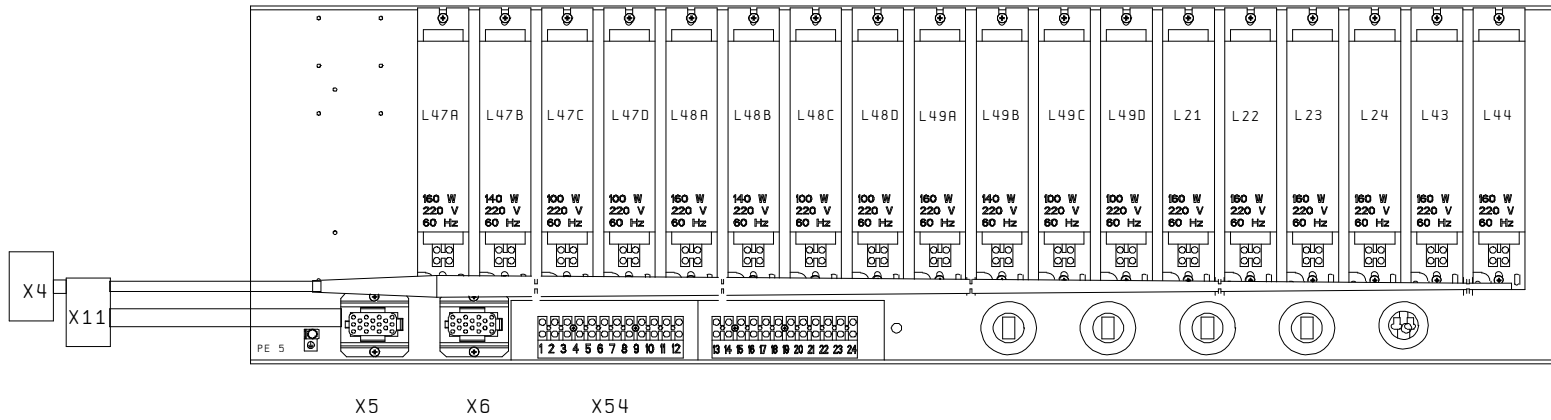
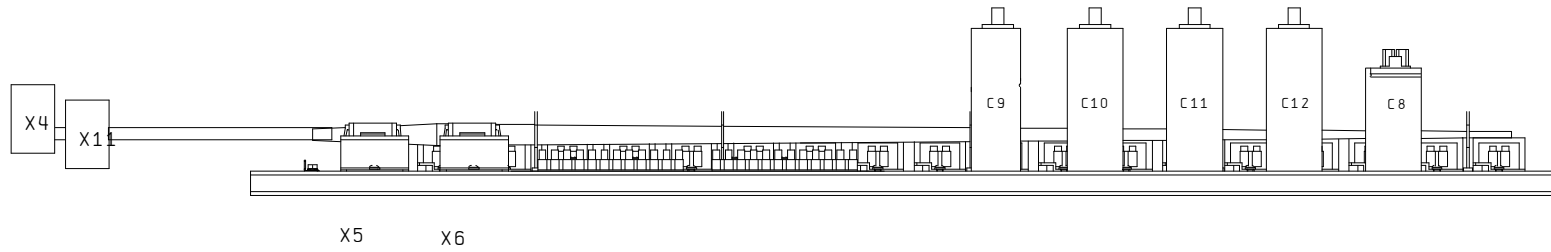

5a

5c

0		1		2		3		4		5		6		7		8		9		
		date		Typ 7019/170				mounting plate #3						drawing-no. A7000/466				UWEPLOR4		
		drawn	NOS	Silverbullet				HP canopy						ident. -no.:				page 5b		
	29. Jul. 2004	checked	11. Aug. 2004											267155				49 pages		
modific.	date	name	norm	origin	repl. for	repl. by														

UWE GmbH
 Buchstrasse 82 · Postfach 2020
 D-73510 Schwäbisch Gmünd



mounting plate no. 4; canopy

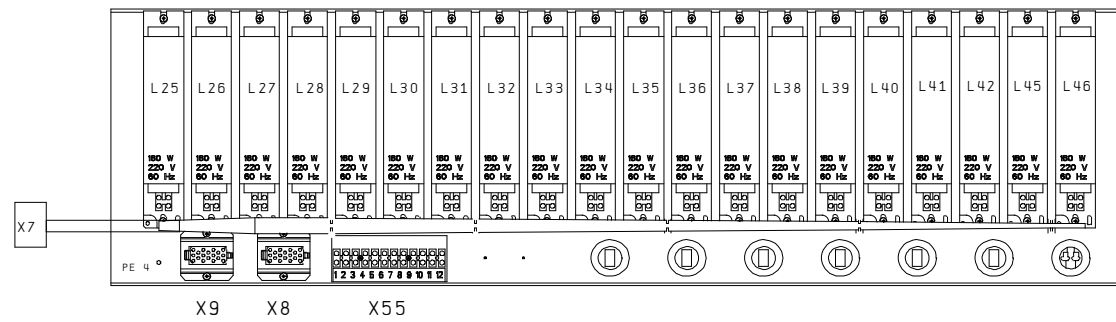
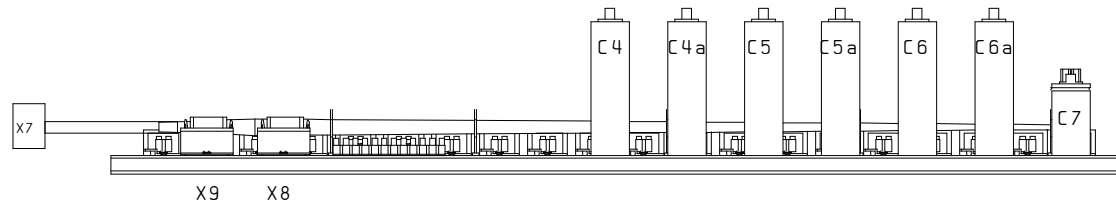

5b

5d

0	1	2	3	4	5	6	7	8	9
	date	Typ 7019/170		mounting plate #4			drawing-no. A7000/466		UWEPL0R4
	drawn	Silverbullet		canopy			ident. -no.:		page 5c
29. Jul. 2004	checked	11. Aug. 2004					267155		49 pages
modific.	date	name	norm	origin	repl. for	repl. by			

uwe GmbH
 Buchstrasse 82 · Postfach 2020
 D-73510 Schwäbisch Gmünd



pedestal housing

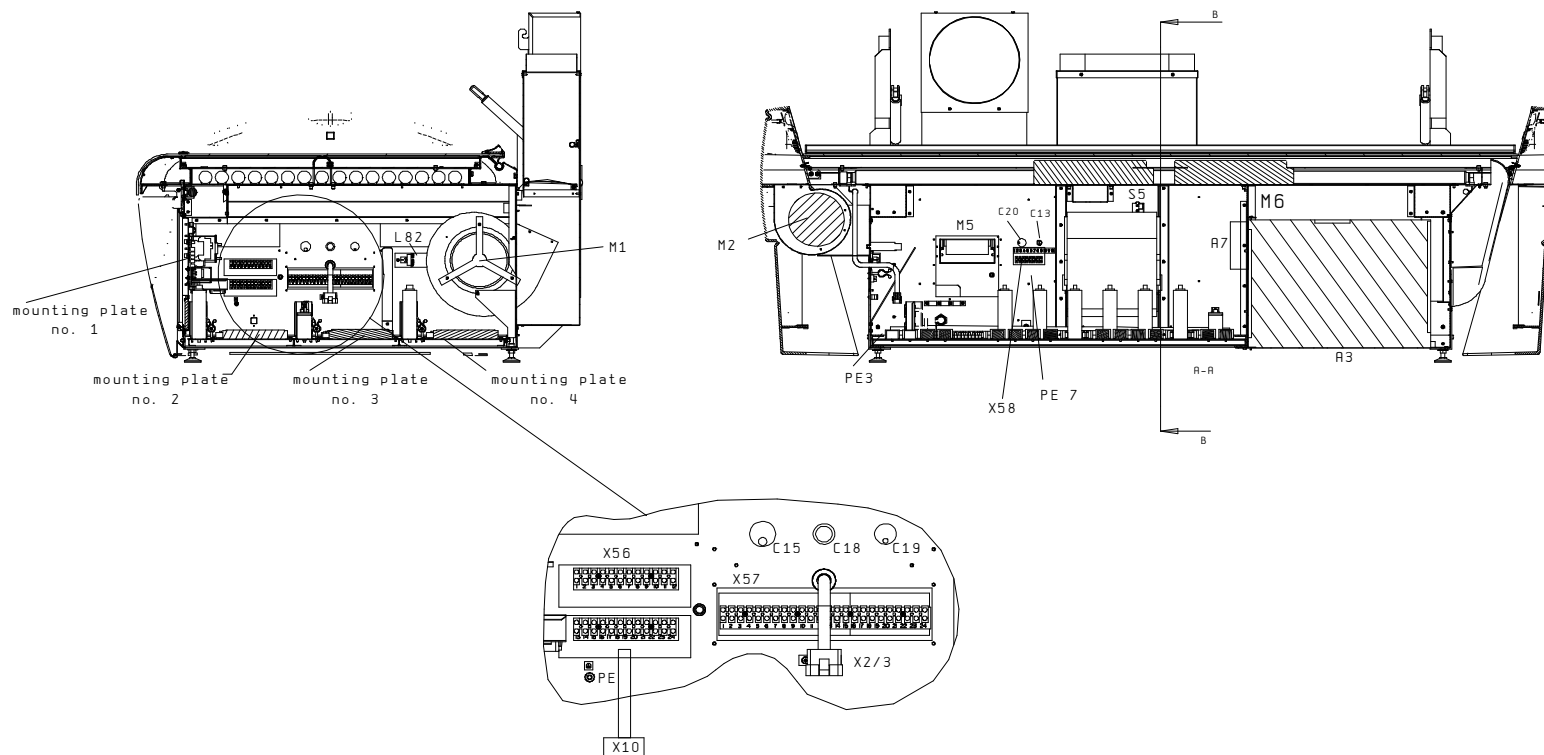

5c

5e

0		1		2		3		4		5		6		7		8		9	
		date		Typ 7019/170				pedestal housing						drawing-no. A7000/466				UWEPL0R4	
		drawn	MAD	Silverbullet															
	29. Jul. 2004	checked	11. Aug. 2004																
modific.	date	name	norm	origin	repl. for	repl. by			uwe GmbH Buchstrasse 82 · Postfach 2020 D-73510 Schwäbisch Gmünd				ident. -no. : 267155		page 5d 49 pages				

canopy

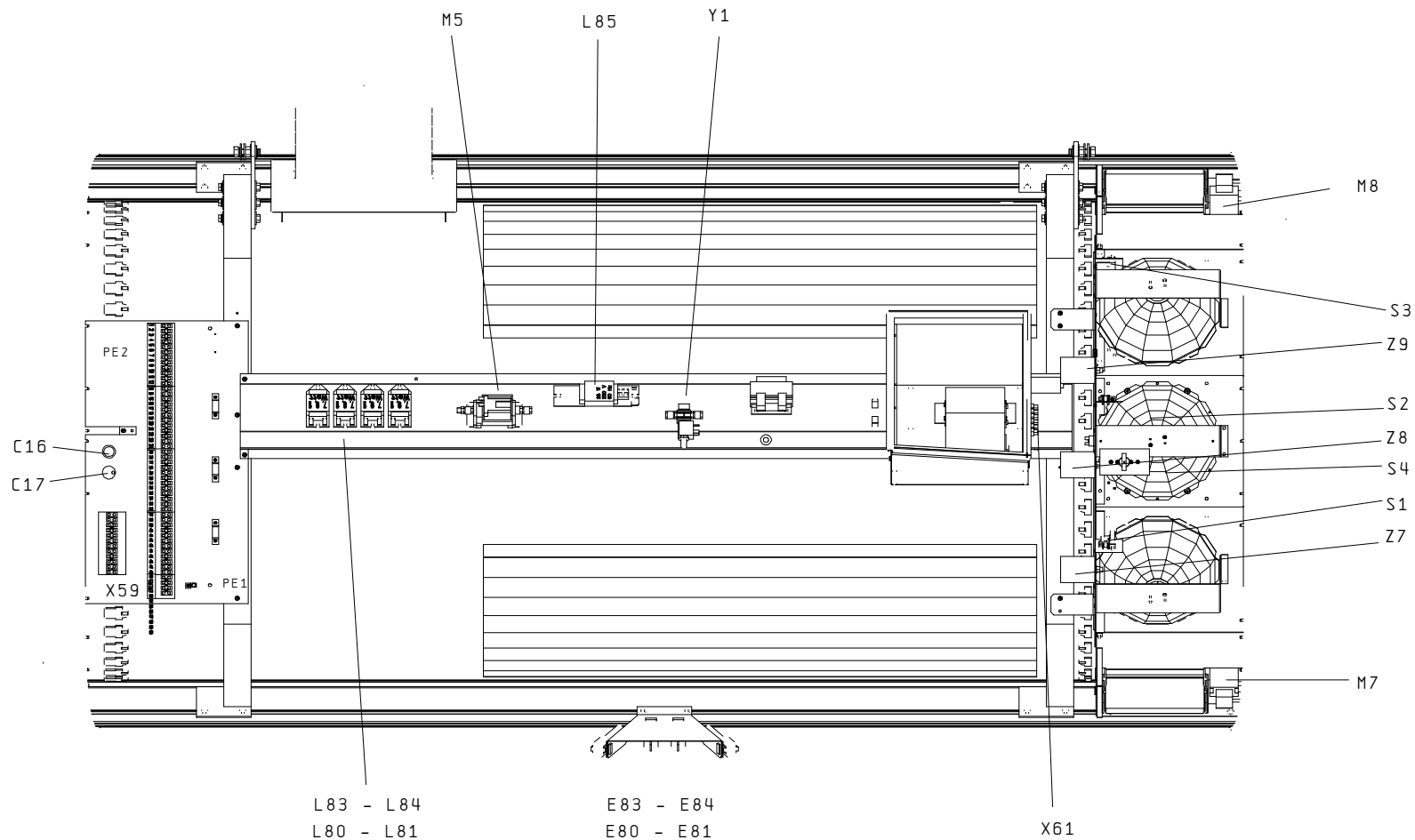

5d

6

0		1		2		3		4		5		6		7		8		9	
		Datum		Typ 7019/170		canopy								Z.-Nr.: A7000/466				UWEPL02	
		Bearb.	NOS	Silverbullet										Mat.-Nr.:				B1. 5e	
	29. Jul. 2004	Gepr.	11. Aug. 2004	Urspr.		Ers. f.		Ers. d.		uwe GmbH Buchstrasse 82 · Postfach 2020 D-73510 Schwäbisch Gmünd		UWE		267155				49 B1.	

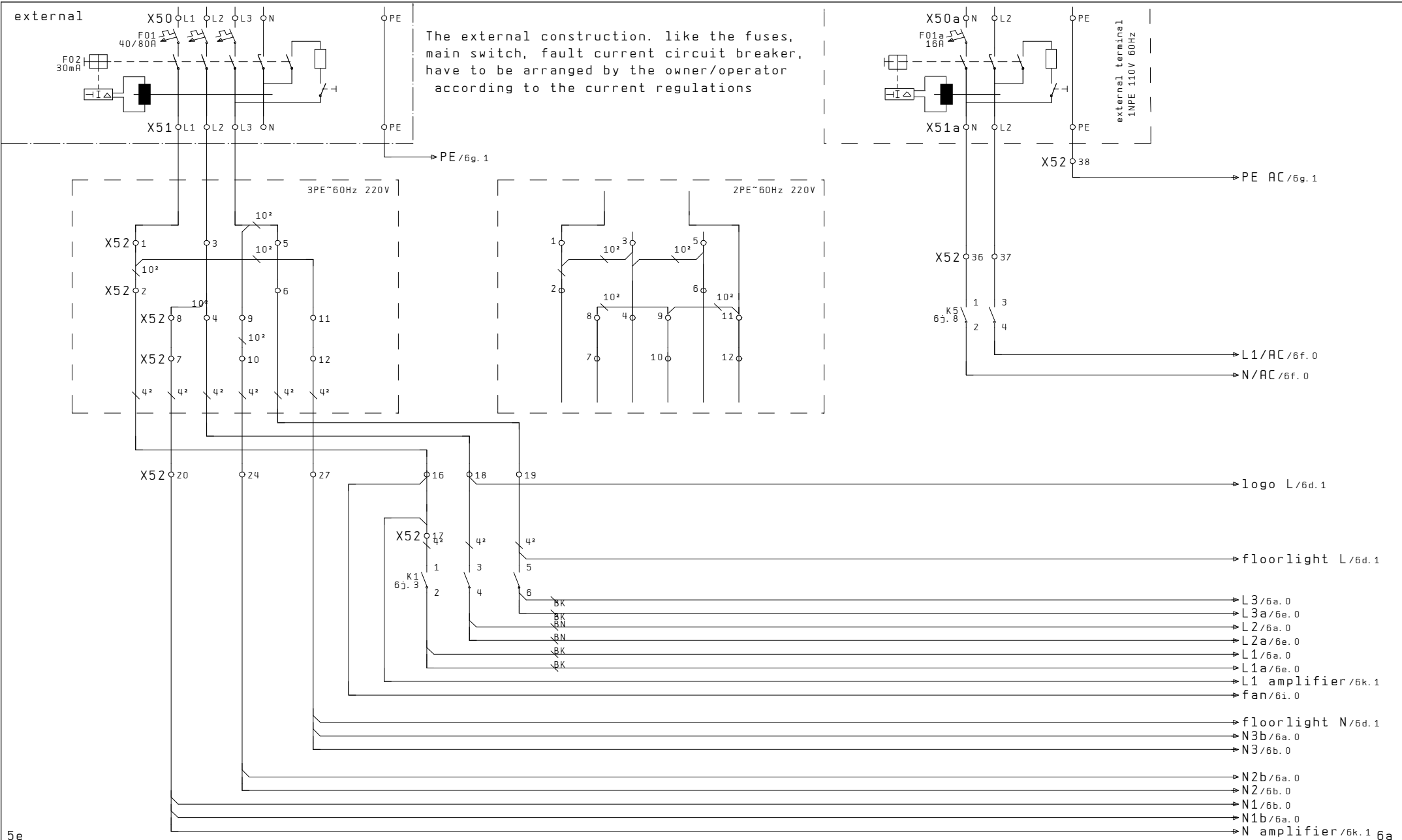

5e

0		1		2		3		4		5		6		7		8		9	
		date		Typ 7019/170	main circuit								drawing-no. A7000/466				UWEFLOR4		
		drawn	MAD	Silverbullet															
	29. Jul. 2004	checked	11. Aug. 2004																
modific.	date	name	norm	origin	repl. for	repl. by							ident. -no. : 267155				page 6 49 pages		

uwe GmbH
Buchstrasse 82 · Postfach 2020
D-73510 Schwäbisch Gmünd

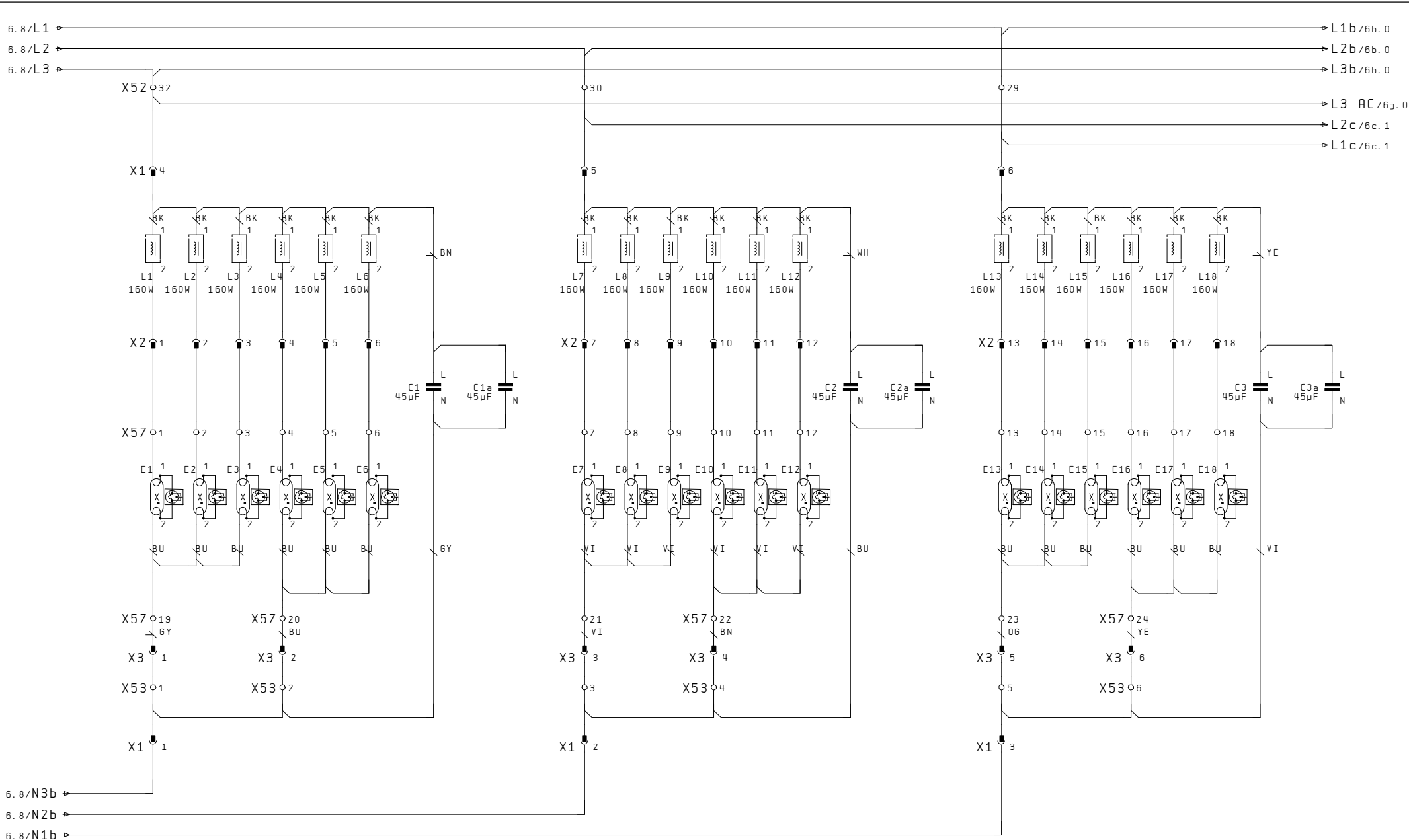

6b

	0	1	2	3	4	5	6	7	8	9
		date	Typ 7019/170		base lamps			drawing-no. A7000/466		UWEFLOR4
		drawn	MAD	Silverbullet						
	29. Jul. 2004	checked	11. Aug. 2004							page 6a
modific.	date	name	norm	origin	repl. for	repl. by		ident. - no. : 267155		49 pages

UWE GmbH
 Buchstrasse 82 · Postfach 2020
 D-73510 Schwäbisch Gmünd



page 6a
 49 pages

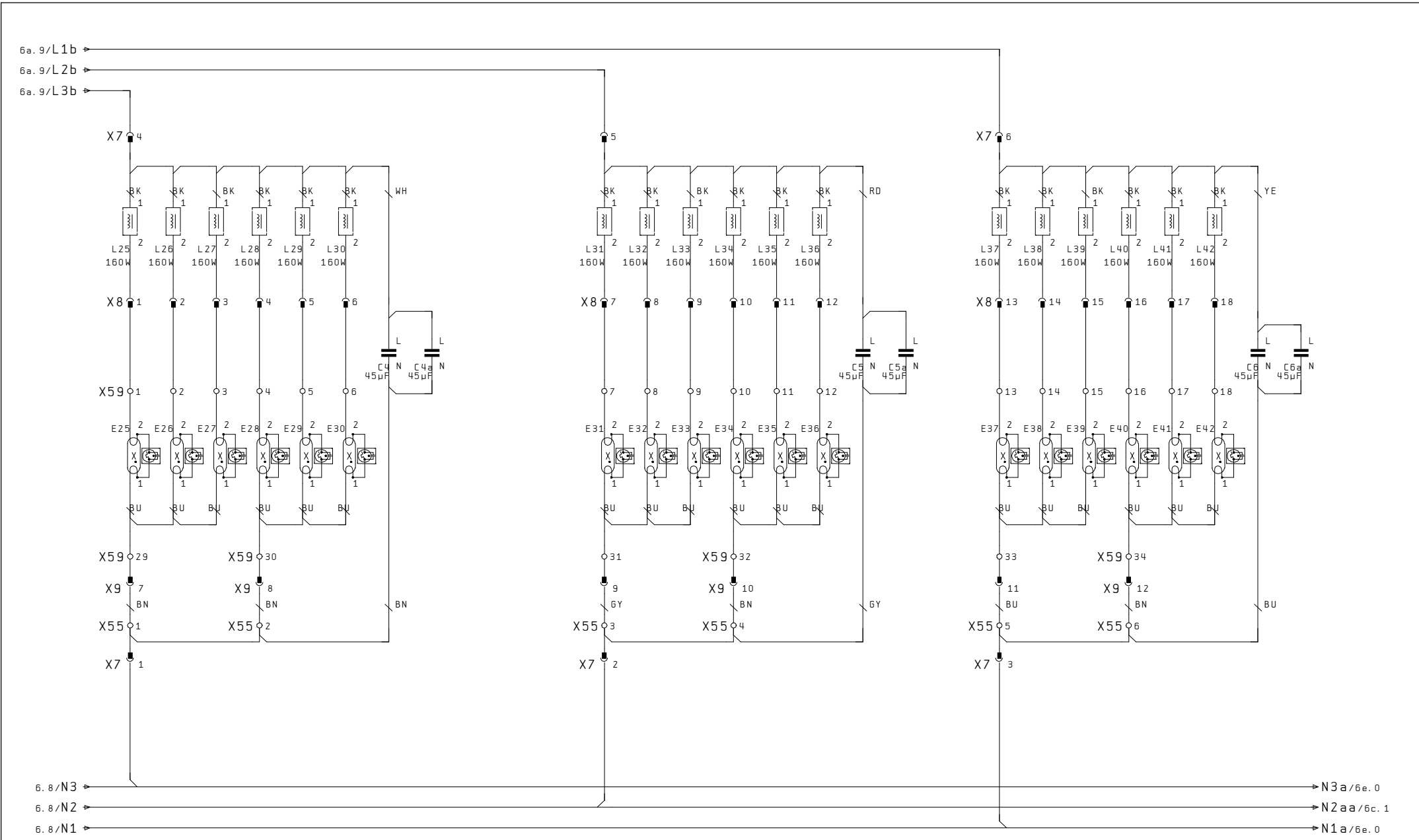

6a		1		2		3		4		5		6		7		8		9		6c
		date		Typ 7019/170		canopy lamps						drawing-no. A7000/466						UWEPL0R4		
		drawn		Silverbullet								ident. - no. :						page 6b		
29. Jul. 2004		checked		11. Aug. 2004								D-73510 Schwäbisch Gmünd						49 pages		
modific.	date	name	norm	origin	repl. for	repl. by														

uwe GmbH
 Buchstrasse 82 · Postfach 2020
 D-73510 Schwäbisch Gmünd



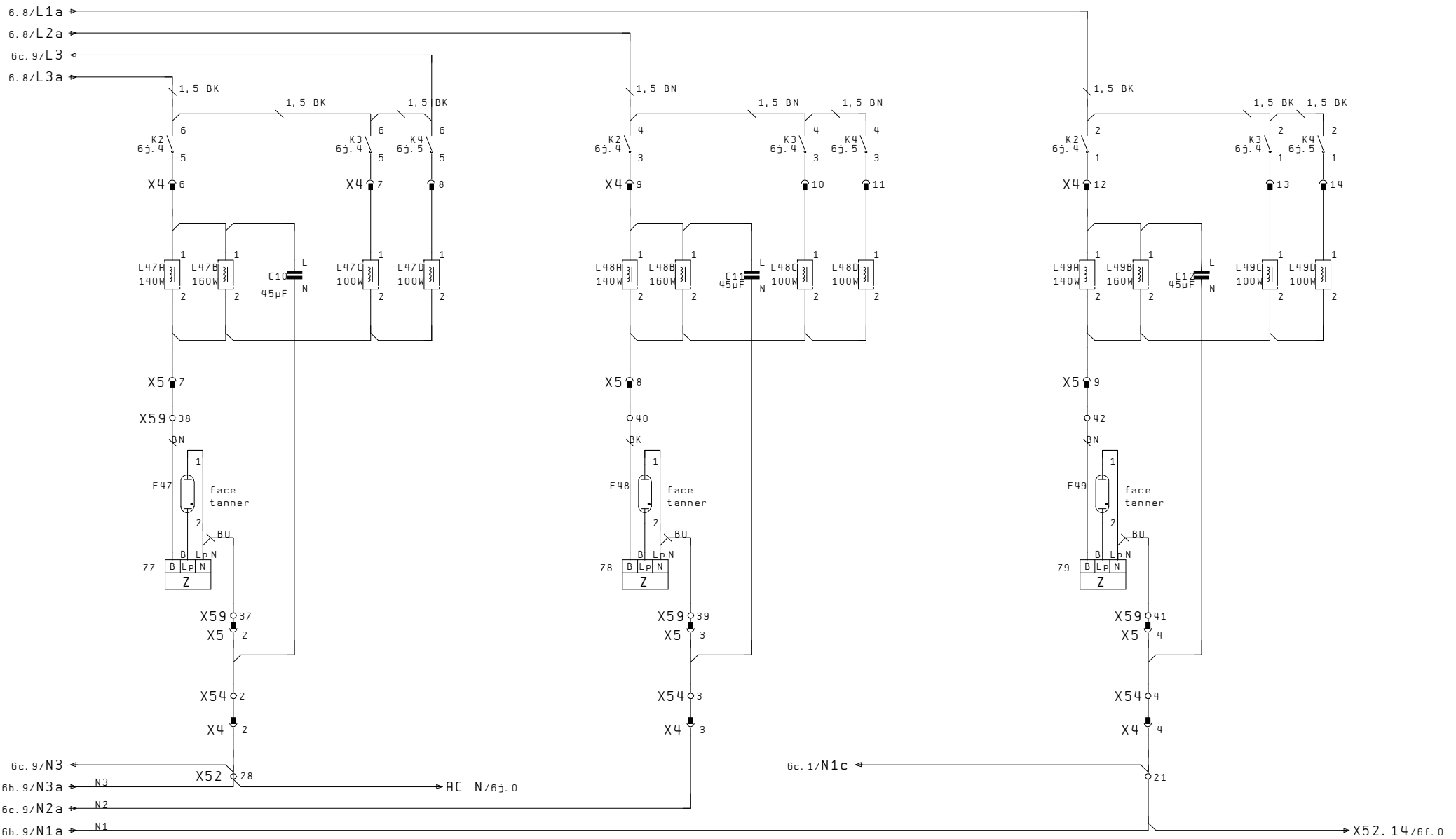

6d

6f

0	1	2	3	4	5	6	7	8	9
	date	Typ 7019/170		HP lamps			drawing-no. A7000/466		UWEPLOR4
	drawn	Silverbullet					ident. - no. :		page 6e
29. Jul. 2004	checked	11. Aug. 2004					267155		49 pages
modific.	date	name	norm	origin	repl. for	repl. by			

uwe GmbH
 Buchstrasse 82 · Postfach 2020
 D-73510 Schwäbisch Gmünd



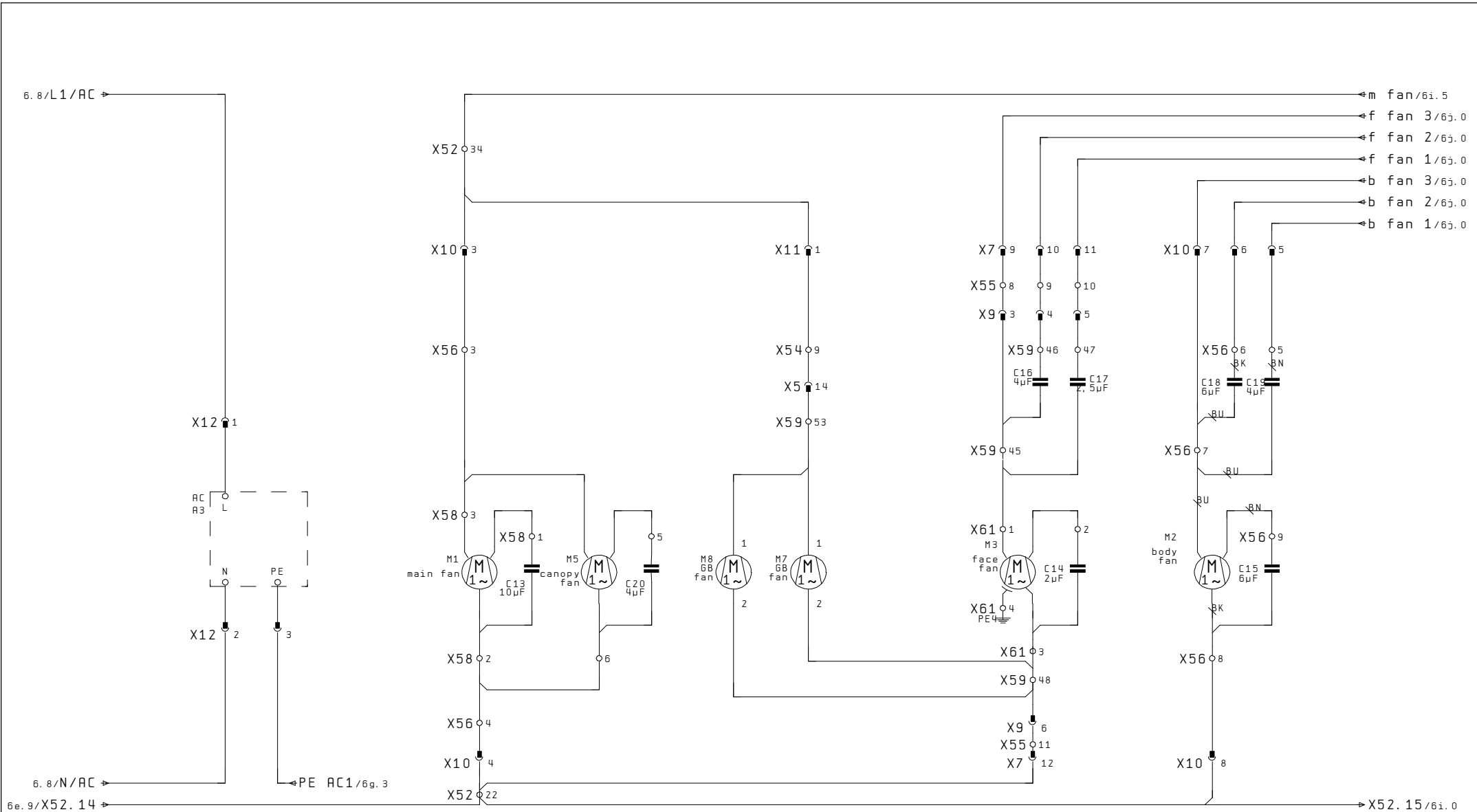

6e

6g

0	1	2	3	4	5	6	7	8	9
	date	Typ 7019/170	fan circuit		uwe GmbH		drawing-no. A7000/466		UWEPLOR4
	drawn	Silverbullet			Buchstrasse 82 · Postfach 2020		ident. -no. :		page 6f
29. Jul. 2004	checked	11. Aug. 2004	origin	repl. for	repl. by	D-73510 Schwäbisch Gmünd	UWE	267155	49 pages
modific.	date	name	norm						

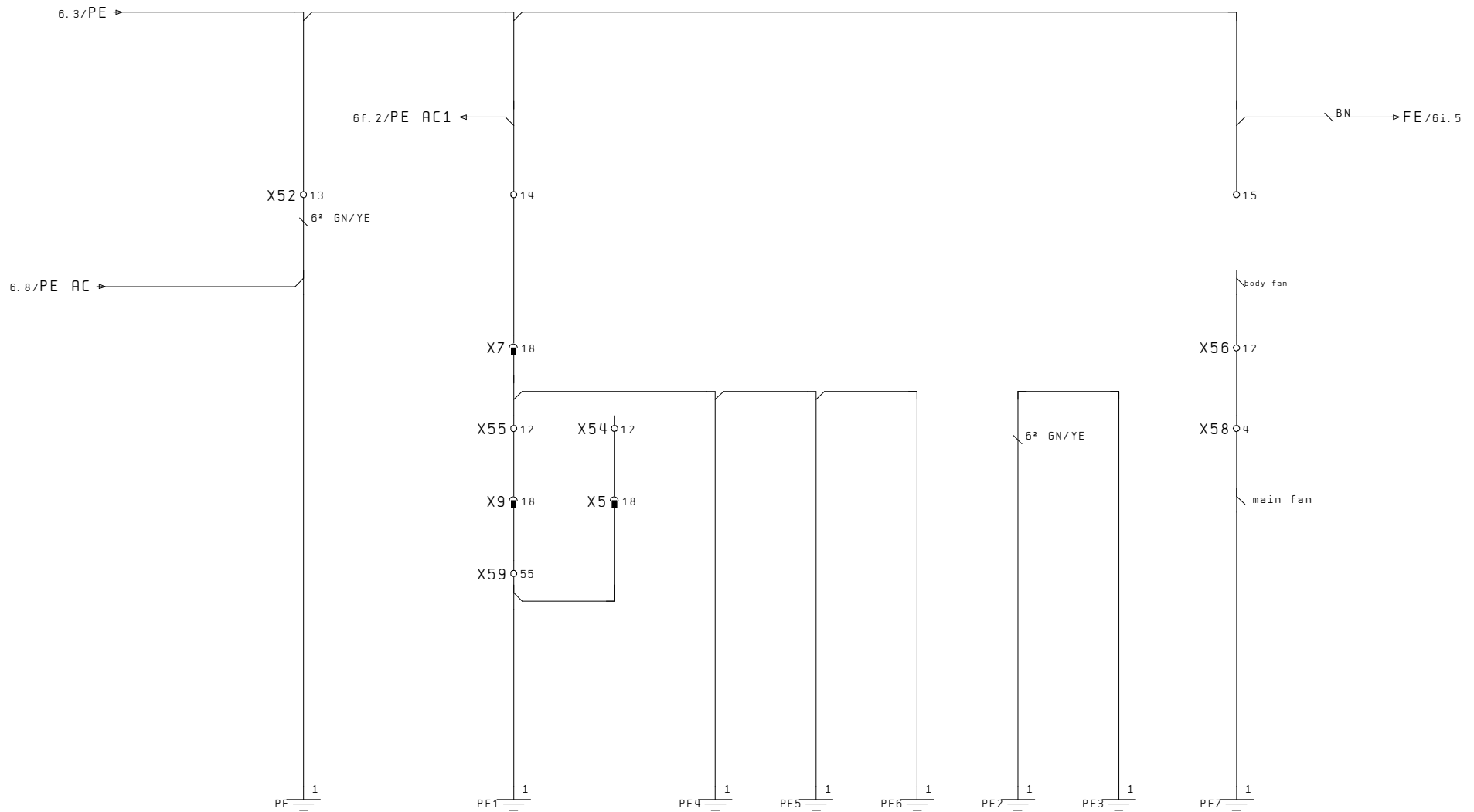

6f

6h

	0	1	2	3	4	5	6	7	8	9
		date	Typ 7019/170		PE			drawing-no. A7000/466		UWEFL0R4
		drawn	NOS	Silverbullet						
	29. Jul. 2004	checked	11. Aug. 2004					ident. -no. :		page 6g
modific.	date	name	norm	origin	repl. for	repl. by		267155		49 pages

uwe GmbH
 Buchstrasse 82 · Postfach 2020
 D-73510 Schwäbisch Gmünd



ident. -no. :
 267155

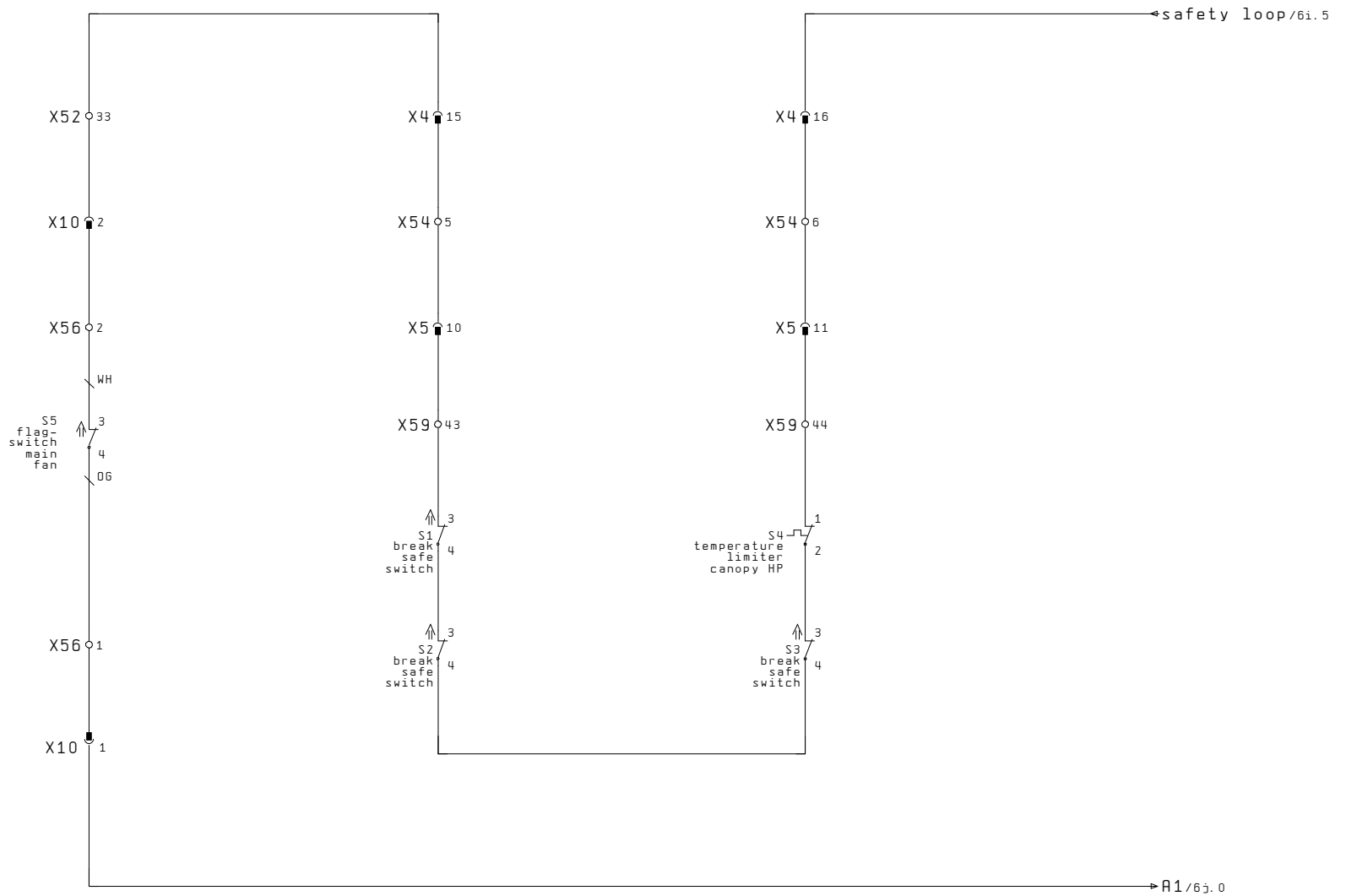

6g

6i

0		1		2		3		4		5		6		7		8		9	
		date		Typ 7019/170				safety loop						drawing-no. A7000/466				UWEPL0R4	
		drawn		NOS		Silverbullet													
29. Jul. 2004		checked		11. Aug. 2004														page 6h	
modific.	date	name	norm	origin	repl. for	repl. by			UWE GmbH Buchstrasse 82 · Postfach 2020 D-73510 Schwäbisch Gmünd		UWE		ident. -no. : 267155				49 pages		

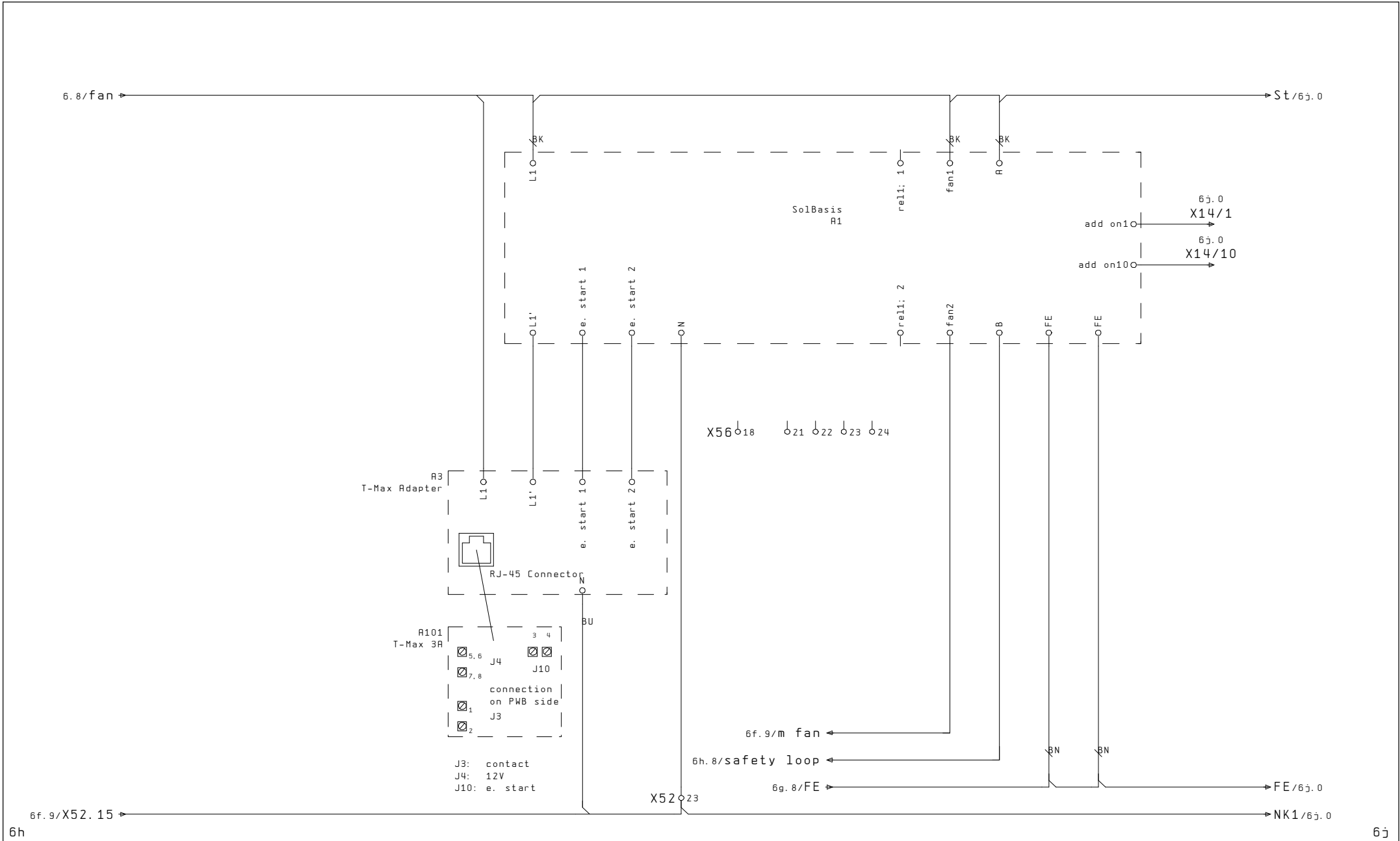

0	1	2	3	4	5	6	7	8	9
	date	Typ 7019/170		control circuit			drawing-no. A7000/466		UWEPL0R4
	drawn	Silverbullet							
	checked								
29. Jul. 2004	11. Aug. 2004								page 6i
modific.	date	name	norm	origin	repl. for	repl. by	ident. -no. : 267155		49 pages

uwe GmbH
 Buchstrasse 82 · Postfach 2020
 D-73510 Schwäbisch Gmünd



drawing-no. A7000/466
 ident. -no. :
 267155

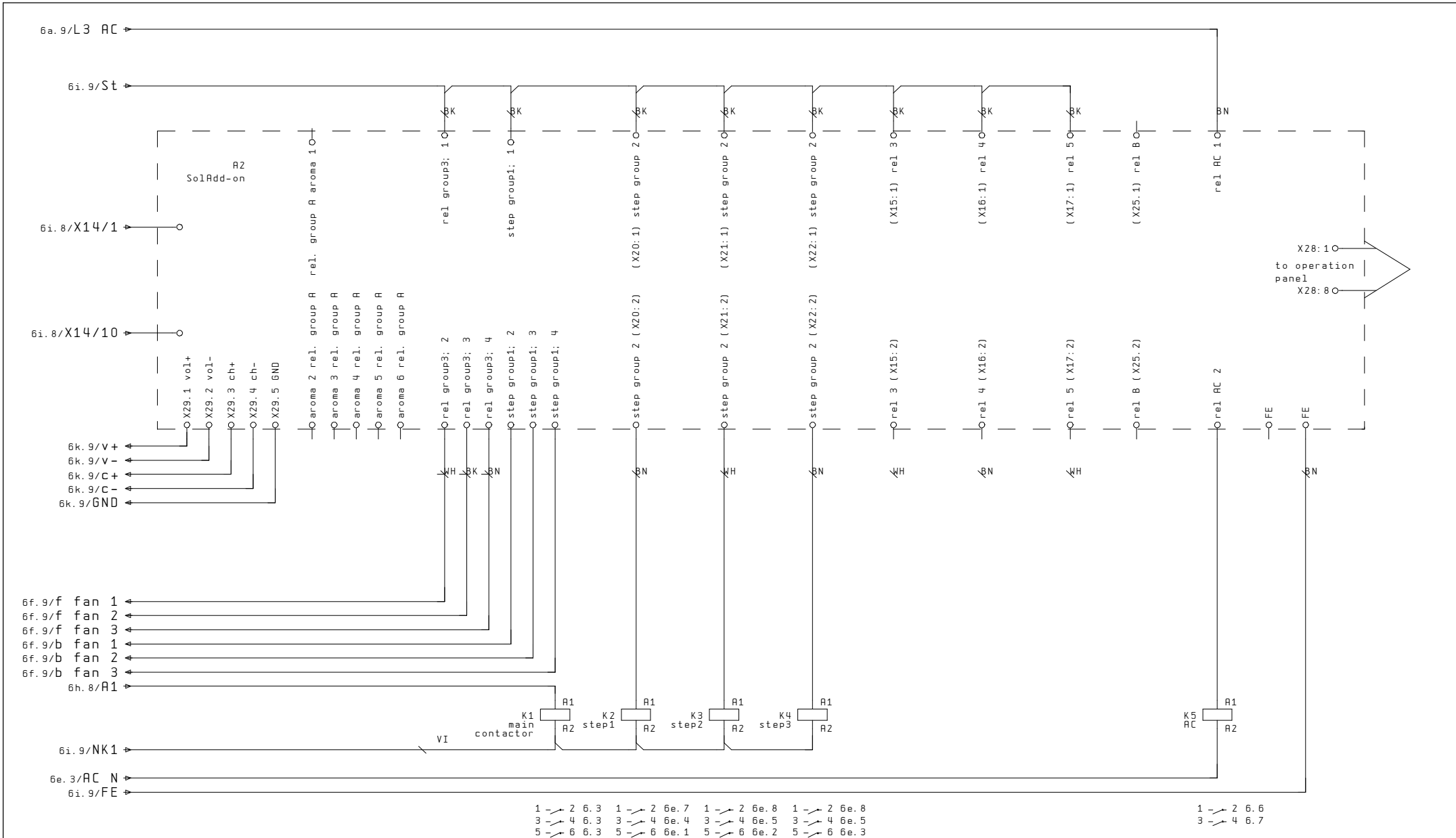

6i

6k

0	1	2	3	4	5	6	7	8	9
	date	Typ 7019/170		control circuit		drawing-no. A7000/466		UWEPLOR4	
	drawn	Silverbullet				ident. -no. :		page 6 j	
29. Jul. 2004	checked	11. Aug. 2004				267155		49 pages	
modific.	date	name	norm	origin	repl. for	repl. by			

UWE GmbH
 Buchstrasse 82 · Postfach 2020
 D-73510 Schwäbisch Gmünd



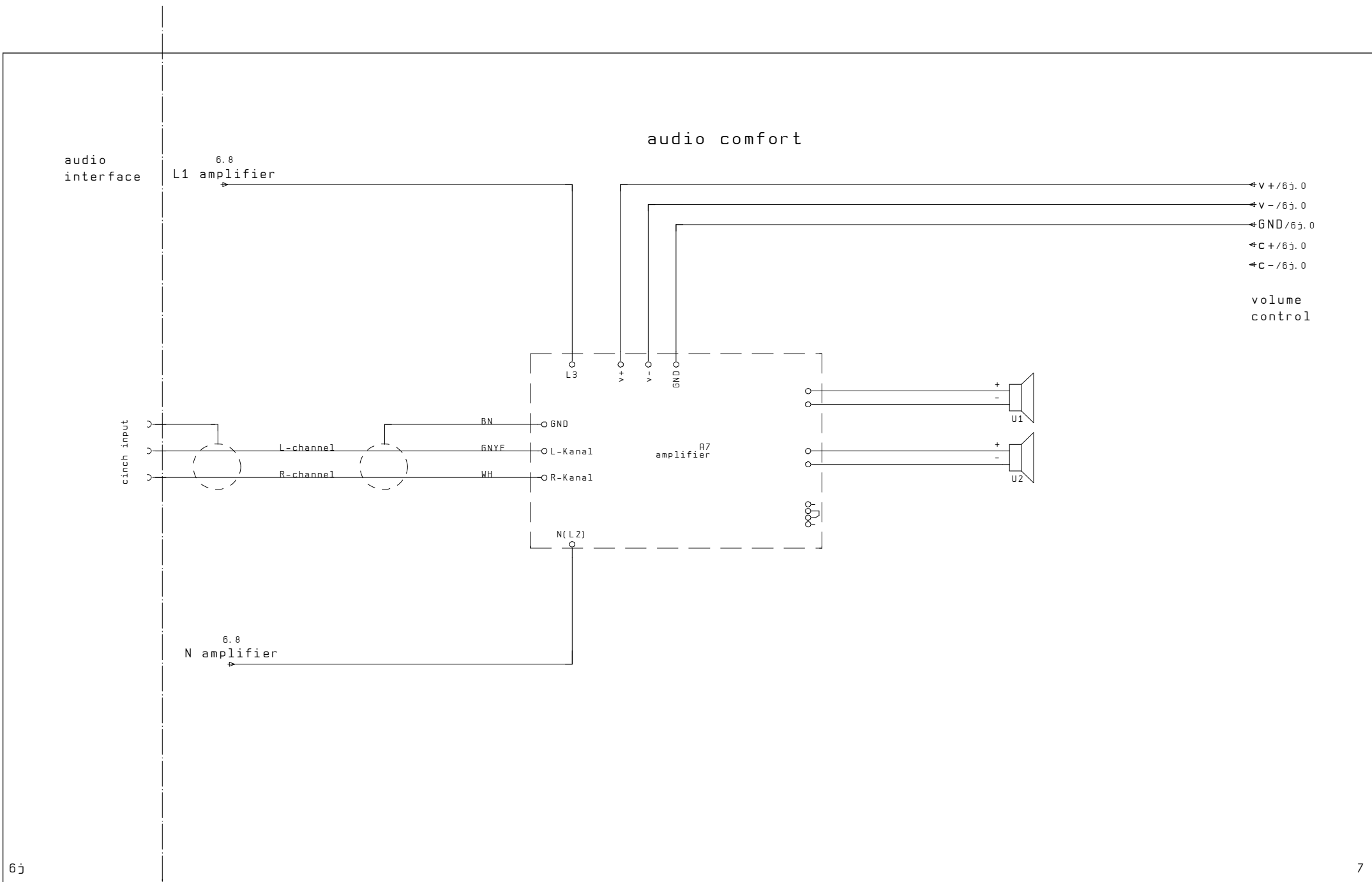

6j

7

0	1	2	3	4	5	6	7	8	9
	date	Typ 7019/170	audio						
	drawn	Silverbullet							
	checked								
29. Jul. 2004	11. Aug. 2004								
modific.	date	name	norm	origin	repl. for	repl. by			

uwe GmbH
 Buchstrasse 82 · Postfach 2020
 D-73510 Schwäbisch Gmünd



drawing-no. A7000/466

ident. -no. : 267155
 page 6k
 pages 49

UWEPL0R4

terminal diagram

identification terminal block	cabelname	cabeltype	connection	finish designation	device connection	bridges	terminal number	connection	finish designation	function text	cabelname	cabeltype	page/path
X2			L1	X57			1	1					6a.1
			L2	X57			2	2					6a.1
			L3	X57			3	3					6a.1
			L4	X57			4	4					6a.2
			L5	X57			5	5					6a.2
			L6	X57			6	6					6a.2
			L7	X57			7	7					6a.4
			L8	X57			8	8					6a.4
			L9	X57			9	9					6a.4
			L10	X57			10	10					6a.5
			L11	X57			11	11					6a.5
			L12	X57			12	12					6a.5
			L13	X57			13	13					6a.7
			L14	X57			14	14					6a.7
			L15	X57			15	15					6a.7
			L16	X57			16	16					6a.7
			L17	X57			17	17					6a.8
			L18	X57			18	18					6a.8

0		1		2		3		4		5		6		7		8		9	
	Datum	29. Jul. 2004		Typ	7019/170			X2											
	Bearb.	NOS			Silverbullet														
	29. Jul. 2004		Gepr.	11. Aug. 2004															
Anderung	Datum	Name	Norm		Urspr.		Ers. f.		Ers. d.										

uwe GmbH
 Buchstrasse 82 · Postfach 2020
 D-73510 Schwäbisch Gmünd



Z.-Nr.: A7000/466

Mat.-Nr.:
 267155

UWEPL02
 B1. 8
 49 B1.

terminal diagram

identification terminal block	cabelname	cabeltype	connection	finish designation	device connection	bridges	terminal number	connection	finish designation	function text	cabelname	cabeltype	page/path
X8			L25	2			1	X59	1				6b.0
			L26	2			2	X59	2				6b.1
			L27	2			3	X59	3				6b.1
			L28	2			4	X59	4				6b.1
			L29	2			5	X59	5				6b.2
			L30	2			6	X59	6				6b.2
			L31	2			7	X59	7				6b.4
			L32	2			8	X59	8				6b.4
			L33	2			9	X59	9				6b.4
			L34	2			10	X59	10				6b.5
			L35	2			11	X59	11				6b.5
			L36	2			12	X59	12				6b.5
			L37	2			13	X59	13				6b.7
			L38	2			14	X59	14				6b.7
			L39	2			15	X59	15				6b.7
			L40	2			16	X59	16				6b.7
			L41	2			17	X59	17				6b.8
			L42	2			18	X59	18				6b.8

0		1		2		3		4		5		6		7		8		9	
	Datum	29. Jul. 2004		Typ	7019/170	X8								Z.-Nr.: A7000/466				UWEPL02	
	Bearb.	NOS			Silverbullet														
	29. Jul. 2004																		
Anderung	Datum	Name	Norm		Urspr.		Ers. f.		Ers. d.					Mat.-Nr.: 267155				B1. 14 49 B1.	

uwe GmbH
 Buchstrasse 82 · Postfach 2020
 D-73510 Schwäbisch Gmünd



terminal diagram

identification terminal block X55	cabelname	cabeltype	6b.0	6b.1	6b.4	6b.5	6b.7	6b.7	6c.2	6f.6	6f.7	6f.7	6f.6	6g.3	
	connection	finish designation	X9 7	X9 8	X9 9	X9 10	X9 11	X9 12	X9 13	X7 9	X7 10	X7 11	X9 6	X7 18 PE4 1	
	device connection	bridges													
	terminal number	connection	1	2	3	4	5	6	7	8	9	10	11	12	
	finish designation	connection	X7 1	C4 N	X7 2	C5 N	X7 3	C6 N	X7 7	C7 N	X9 3	X9 4	X9 5	X7 12	X9 18
	BN	BN		X											
	GY	GY				X									
	BU	BU						X	X						
	BK	BK													
	function text														
	GRD														

	Datum	29. Jul. 2004		Typ	7019/170		X55							
	Bearb.	NOS			Silverbullet									
	Gepr.	11. Aug. 2004												
Anderung	Datum	Name	Norm	Urspr.	Ers. f.	Ers. d.								

uwe GmbH
 Buchstrasse 82 · Postfach 2020
 D-73510 Schwäbsch Gmünd



Z.-Nr.: A7000/466

Mat.-Nr.: 267155

UWEPL02
 Bl. 24
 49 Bl.

terminal diagram

identification terminal block	cabelname	cabeltype	connection	finish designation	device connection	bridges	terminal number	connection	finish designation	function text	WH	BN	BK	BU	OG	BN	BK	BU	OG	page/path		
																				6h. 2	6h. 2	
X56			4	S5			1	1	X10	safety loop					X						6h. 2	6h. 2
																					6h. 2	6h. 2
																					6f. 3	6f. 3
																					6f. 3	6f. 3
																					6f. 8	6f. 8
																					6f. 8	6f. 8
																					6f. 8	6f. 8
																					6f. 8	6f. 8
																					6d. 3	6d. 3
																					6d. 3	6d. 3
																					6g. 7	6g. 7
																					6i. 5	6i. 5
																					6i. 5	6i. 5
																					6i. 5	6i. 5
																					6i. 6	6i. 6
																					6i. 6	6i. 6

0	1	2	3	4	5	6	7	8	9
	Datum 29. Jul. 2004	Typ 7019/170		X56					
	Bearb. NOS	Silverbullet							
	Gepr. 11. Aug. 2004								
Anderung	Datum	Name	Norm	Urspr.	Ers. f.	Ers. d.			

uwe GmbH
 Buchstrasse 82 · Postfach 2020
 D-73510 Schwäbisch Gmünd



Z.-Nr.: A7000/466

Mat.-Nr.: 267155

UWEPLOZ
 B1. 25
 49 B1.

