

Indoor Tanning Equipment

Care and Use Instructions

Montego Bay Legend

2600BX & 3200BX

Montego Bay

1040 Wilt Ave.

Ridgefield, NJ 07657

1-800-FAST TAN

100143

REV. 2

UNIT SPECIFICATIONS

	MB-2600BX	MB-3200BX
MODEL	MB-2600BX	MB-3200BX
LENGTH	83.75"	83.75"
WIDTH	35.5"	40.5"
HEIGHT (Closed)	30"	31"
HEIGHT (Open)	50.5"	55.5"
NUMBER OF LAMPS	26	32
VOLTAGE	240 VAC	240VAC
AMPERAGE	19.5 AMPS	24.0 AMPS
SHIPPING WEIGHT	540 POUNDS	620 POUNDS

DANGER – ULTRAVIOLET RADIATION Follow Instructions. Avoid overexposure. As with natural sunlight, overexposure can cause eye and skin injury and allergic reactions. Repeated exposure may cause premature aging of the skin and skin cancer. **WEAR PROTECTIVE EYE WEAR; FAILURE TO MAY RESULT IN SEVERE BURNS OR LONG-TERM INJURY TO THE EYES.**

Medication or cosmetics may increase your sensitivity to the ultraviolet radiation. Consult physician before using sunlamp if you are using medications or have a history of skin problems or believe yourself especially sensitive to sunlight. If you do not tan in the sun, you are unlikely to tan from use of this product.

This unit utilizes UVA lamps. Replace with SunMaster Plus (P/N 26241) lamps, or FDA approved equivalent.

To obtain recommended exposure at a minimum distance of 1/2" (13 mm) measured with a standard ruler, lie on acrylic surface of lounge and lower canopy. Canopy will stop at 12 inches (305 mm) from lounge acrylic surface. The use of any other position may result in overexposure

RECOMMENDED EXPOSURE SCHEDULE

	WEEK 1	WEEK 2	WEEK 3	WEEK 4	WEEK 5 &
SKIN TYPE	1st-3rd Session	4th-6th Session	7th-10th Session	11th-15th Session	Subsequent Sessions
II - FAIR	3 MIN.	5 MIN.	8 MIN.	9 MIN.	10 MIN.
III - AVERAGE	3 MIN.	6 MIN.	8 MIN.	9 MIN.	10 MIN.
IV - BROWN	3 MIN.	7 MIN.	9 MIN.	10 MIN.	10 MIN.
V - DARK BROWN	3 MIN.	7 MIN.	9 MIN.	10 MIN.	10 MIN.

Tanning can begin on a regular basis (allowing 48 hours between sessions). An appearance of tanning normally occurs after a few exposures and maximizes after four (4) weeks of exposure following the recommended exposure schedule for your skin type. In order to provide for maintenance of a tan, a maximum of two (2) weekly ten minute sessions is recommended from the fifth week onward.

USE PROTECTIVE EYEWEAR WHENEVER THE EQUIPMENT IS ENERGIZED. READ THE INSTRUCTION BOOKLET BEFORE USING THIS PRODUCT.

Instructions accompanying this product should always be followed to avoid or minimize potential injury.

This product is in conformity with performance standards for sunlamp products under CFR 21 PART 1040.20.

WARNING:

If you have been diagnosed by a physician as being allergic to the sun or are currently taking photosensitive medications, consult your physician before using the sunlamp.

Certain drugs – particularly those designed to enhance photosensitivity – may cause individuals under their influence to experience adverse effects, and those people should avoid exposure to UV sources of all kinds. Doctors will advise persons taking these drugs of possible adverse effects.

It is recommended that only one person at a time use the tanning system. Use protective eyewear while taking a tanning session. Protective eyewear is provided with each sunlamp sold.

Occasionally, persons using the tanning system will experience a slight reddening of the skin – usually in small patches – after the second or third session. This redness is often accompanied by an itching sensation. This is nothing more than a heat "rash" caused by heat from the lamps within the system. It is generally very limited and caused by constant contact of the skin with the acrylic surface. It will go away within approximately 24 hours and should not reappear. This rash can be lessened or prevented by turning over occasionally during sessions in the sunlamp, and by applying moisturizing lotion to the affected area after the tanning session is completed.

CAUTION

WHILE THERE IS NO IMMEDIATE CLINICAL EVIDENCE REGARDING UVA EXPOSURE AND ITS EFFECTS UPON EXPECTANT MOTHERS, IT IS STRONGLY ADVISED THAT EXPECTANT MOTHERS BE DISCOURAGED FROM USING THE SUNLAMP.

EXPOSURE TIMES AND FREQUENCIES

Melanin, the brownish pigment produced by special cells in the base layer of the skin determines the individual's ability to tan. As the skin is exposed to ultraviolet rays, the melanin is activated and combines with protein cells that rise to the skin's surface, thus producing a tan. The amount of melanin in your body determines how quickly and darkly you tan.

NOTE

THE TAN PRODUCED BY THE SUNLAMP IS A DEEP, RICH "COSMETIC" TAN. HOWEVER, REGARDLESS OF HOW MUCH AN INDIVIDUAL MAY TAN WITH THIS UNIT, IT WILL NOT PROVIDE ADEQUATE PROTECTION AGAINST OVEREXPOSURE TO NATURAL SUNLIGHT OR UVB TANNING SYSTEMS.

- | | |
|----------------|---|
| SKIN TYPE II- | THIS IS THE INDIVIDUAL THAT USUALLY BURNS EASILY AND SEVERELY, TANS MINIMALLY OR LIGHTLY AND PEELS. |
| SKIN TYPE III- | OFTEN REFERRED TO AS "AVERAGE" COMPLEXION, BURNS MODERATELY AND TANS ABOUT AVERAGE. |
| SKIN TYPE IV- | THIS INDIVIDUAL BURNS MINIMALLY, TANS EASILY AND ABOVE AVERAGE WITH EACH EXPOSURE. |
| SKIN TYPE V- | THIS INDIVIDUAL RARELY BURNS, TANS EASILY. |

RECOMMENDED EXPOSURE SCHEDULE

SKIN TYPE	WEEK 1 1st-3rd Session	WEEK 2 4th-6th Session	WEEK 3 7th-10th Session	WEEK 4 11th-15th Session	WEEK 5 & Subsequent Sessions
II - FAIR	3 MIN.	5 MIN.	8 MIN.	9 MIN.	10 MIN.
III - AVERAGE	3 MIN.	6 MIN.	8 MIN.	9 MIN.	10 MIN.
IV - BROWN	3 MIN.	7 MIN.	9 MIN.	10 MIN.	10 MIN.
V - DARK BROWN	3 MIN.	7 MIN.	9 MIN.	10 MIN.	10 MIN.

No two individual skin tones are the same. A tan to one person may be different to another, and session length may vary. It is recommended that, following a tanning session, a skin moisturizer be applied. This promotes a smoother more even looking tan. Equally important - many facial make-ups have oil bases and should be removed prior to each tanning session.

NOTE

SINCE THE BACK AND STOMACH AREAS OF THE BODY WILL RECEIVE THE MAJORITY OF THE TANNING RAYS, IT IS RECOMMENDED THAT INDIVIDUALS SPEND ONE HALF OF EACH SESSION LYING ON EACH SIDE OF THE BODY TO ACHIEVE A FULL-BODIED TAN.

SINCE YOUR SUNLAMP WILL CAST OFF SOME HEAT, IT IS RECOMMENDED THAT A SMALL FAN BE USED TO IMPROVE AIR CIRCULATION DURING SESSIONS. LIKEWISE, ADEQUATE VENTILATION OF THE ROOM OR BOOTH HOUSING THE SUNLAMP IS REQUIRED FOR COMFORTABLE OPERATION.

WARNING

COMMERCIALY AVAILABLE CREAMS, LOTIONS AND OILS CONTAIN SUNSCREENS WHICH FORM A PHYSICAL BARRIER ON THE SKIN THAT PREVENTS THE UVA RAYS FROM PENETRATING AND INDUCING A TAN. IT IS RECOMMENDED THAT YOU USE ONLY CREAMS, OILS OR LOTIONS THAT DO NOT CONTAIN POLYETHYLENE/GLYCOL LAURATE OR POLYETHYLENE/GLYCOL MONO LAURATE AND ARE DESIGNED FOR USE WITH INDOOR TANNING EQUIPMENT. FAILURE TO COMPLY WITH RECOMMENDATIONS AND WARNINGS STATED ABOVE MAY VOID THE MANUFACTURER'S WARRANTY.

OPERATING YOUR SUNLAMP

This unit is equipped with a remote timer. The timer is used to preselect the actual tanning time and switch on the sunlamp. The timer will automatically switch the sunlamp off when the preselected time expires.

To operate timer, rotate knob clockwise to the desired tanning time, timer can be set to a maximum of ten (10) minutes. Refer to the exposure times and frequencies for correct timer setting.

After the timer is set (and the "on-off" switch is "on"), the unit is ready for immediate operation. Lie on acrylic surface of lounge and lower canopy. The canopy will stop with its acrylic surface 12 inches (305 mm) from the acrylic surface of the lounge. There is no additional time required for lamp start-up.

CARE AND CLEANING OF YOUR SUNLAMP

CAUTION: THE SUNLAMP SHOULD BE DISCONNECTED FROM THE POWER SUPPLY BEFORE CLEANING OR DISINFECTING THE INSIDE OF THE ACRYLIC. AVOID WATER OR SOLUTION ENTERING THE LAMP COMPARTMENT.

After each session is completed, spray the acrylic surface with a specially formulated UVT (ultraviolet transmitting) acrylic cleaner. Wipe the surface of the acrylic with a clean cloth. The acrylic should never be wiped with a dry cloth because this will generate a slight static charge which will attract dust.

For maximum efficiency of your sunlamp, periodic cleaning of lamps, reflectors, acrylics, fans, and the inside of the unit is required.

CAUTION: FAILURE TO CLEAN BEDS, FANS, AND THE INSIDE OF YOUR SUNLAMP COULD VOID THE WARRANTY.

CAUTION: DO NOT USE EXCESSIVE AMOUNTS OF WATER, ANY ABRASIVE CLEANERS, OR ANY SPRAY CLEANER THAT IS NOT SPECIFICALLY DESIGNED FOR USE WITH ACRYLIC SURFACES. DO NOT USE ALCOHOL.

Note: Periodic polishing of the exterior painted surface may be necessary to maintain the finish. An automotive polish, not wax, should be used. Do not clean with anything that may damage the paint.

To obtain repairs and recommended replacement components which are compatible with this unit, including UVT acrylic cleaner, protective eyewear, lamps, acrylic, timers, reflectors, and other parts, which will, if installed and used as instructed, result in continued compliance with CFR 21 1040 20., please contact the Manufacturer:

MONTEGO BAY

1040 Wilt Ave.

RIDGEFIELD, NJ 07657

1-800-FAST TAN

RELAMPING INSTRUCTIONS

CAUTION: REPLACE ONLY WITH SUNMASTER PLUS (P/N 26241) LAMPS, OR FDA APPROVED EQUIVALENT.

1. Disconnect unit from power source
2. Remove acrylic from unit by removing the acrylic retaining strip located along one long edge of the acrylic and sliding the acrylic out.
3. Push lamp toward the spring loaded lampholder to disengage the lamp from the stationary lampholder. Remove lamp.
4. Replace by inserting end of lamp in spring loaded lampholder at the end of the unit and push until the lamp will insert and properly seat in stationary lampholder at the other end of the unit.
5. Clean and replace acrylic shield. (Refer: **CARE AND CLEANING**). Reconnect unit to power.

Assembly Instructions

1. Open cartons, remove packing, remove and inspect unit and all associated parts and hardware per the hardware drawings in the back of this manual.
2. Leg Assembly
 - a. Place a leg side piece on a flat surface and attach an end piece to each end using (4) 1/4-20 x 3/4" machine screws and 1/4-20 keps nuts. (Note: Also use screw dap washer and plastic caps on outer-away from skirt-side only.)
 - b. Flip assembly over and attach other leg side piece using (4) more 1/4-20 x 3/4" machine screws and 1/4-20 keps nuts.
 - c. Repeate steps a and b for second leg.
3. Leg Installation (See Figure #1)
 - a. Turn lounge half of unit upside down and position legs over mounting holes in bottom panel.
 - b. Attach legs using (4) 5/16-18 x 1" bolts, flat washers and lockwashers each. Tighten all bolts thoroughly.
 - c. Turn lounge right side up and rest on legs.
4. Hinge Installation
 - a. Attach hinge assemblies (with brake shoes installed) to each end of lounge using (2) 3/8-16 x 2 1/4" bolts, (2) bolt cap washers and (2) space washers each. Be sure that the side of hinge assembly with large (1-7/8" dia.) hole at top, is on the inside - toward the bed. Do not tighten bolts completely or install bolt caps at this time.
 - b. Attach pneumatic cylinder clevis to tab on each hinge assembly using 5/16-18 x 1" bolts and elastic stop nuts. Remove wire locking clips from ball sockets at top of pneumatic cylinders.
 - c. Lift canopy half of unit (with brake bosses attached) and slide bosses into shoes in hinge assemblies (top ends of hinge assemblies must be forced outward in order to accomplish this). Insert (1) 3/8 -16 x 2-1/4" bolt, Teflon washer, and 3/8 flat washer in each end to hold position. With an assistant holding front edge of canopy at full open position, snap ball sockets on the pneumatic cylinders onto ball studs on canopy. Replace wire locking clips.
 - d. Tighten all bolts thoroughly and snap (3) plastic bolt caps into place over bolt heads on each end of unit. Then, adjust brakes (using 5/32 allen wrench in hardware kit) to provide desired ease of operation.
5. Electrical Hook-up
 - a. Connect jumper cord from canopy to lounge by aligning male plug on jumper with female receptacle on rear of lounge and tightening locking nut.
 - b. Connect cord from remote timer to unit by aligning male plug on timer cord with female receptacle on rear of lounge and tightening locking nut.
 - c. Plug cord from body fan into receptacle of rear of canopy.
 - d. The sunlamp must be connected only to a 240 volt, single phase power supply and must be permanently wired, in accordance with local codes, from the wall to the unit using 10 gauge, 4-wire single phase wiring. A circuit breaker is required. No power cords or plugs are supplied with this unit. This wiring should be performed by a qualified electrician.

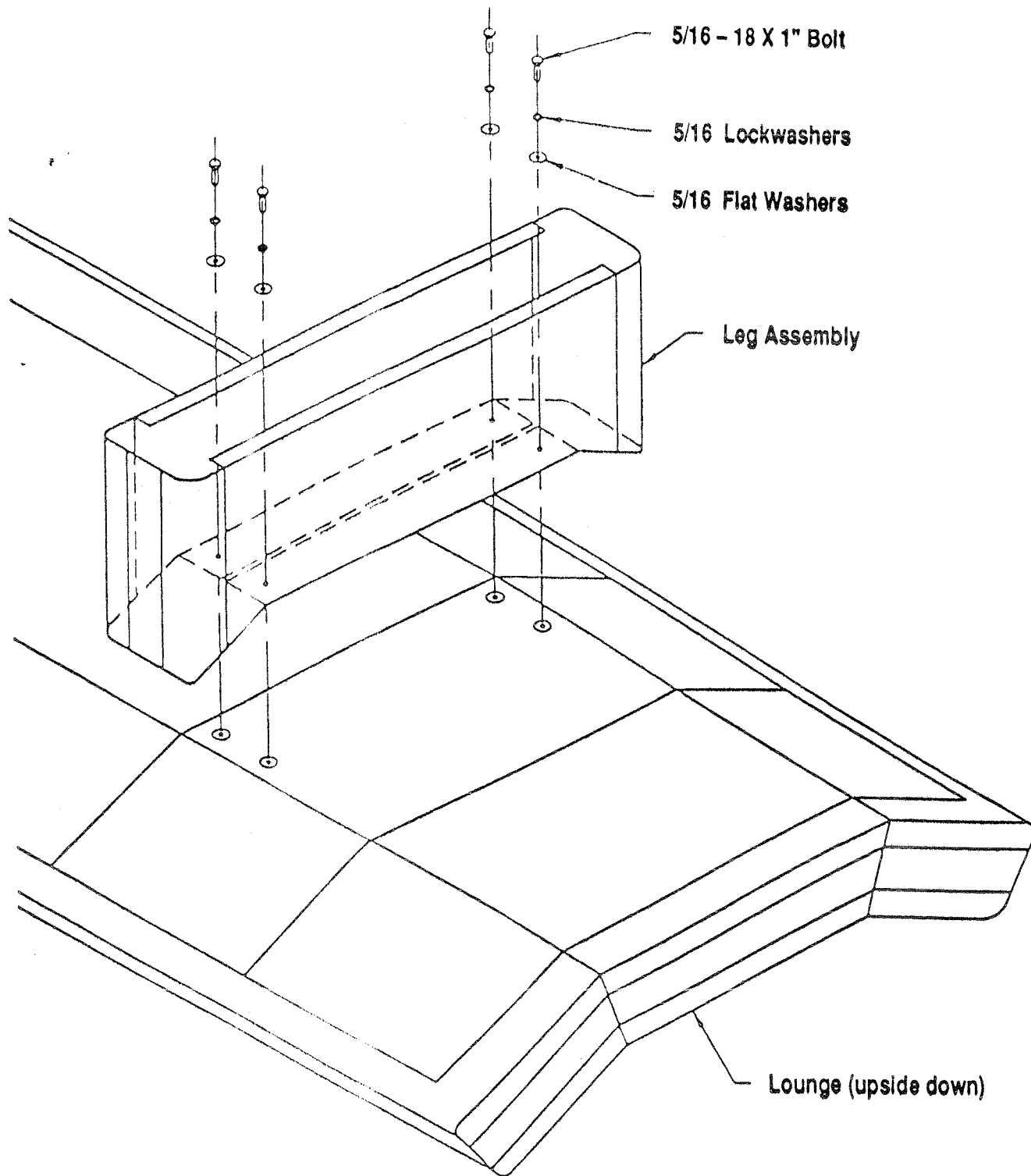

FIGURE #1
Leg Installation

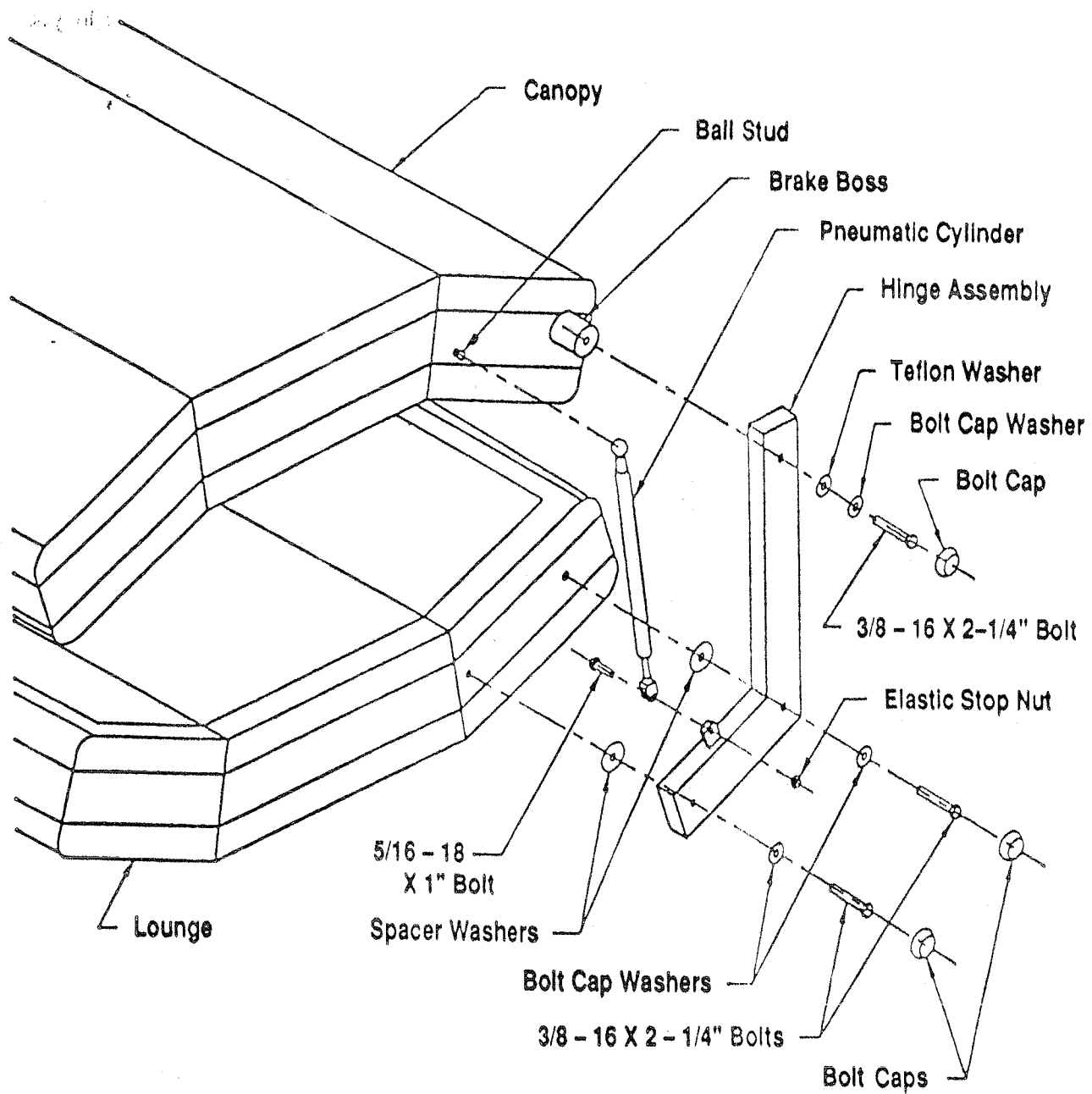

FIGURE # 2
Hinge Installation

GENERAL TROUBLE SHOOTING GUIDE

The following trouble shooting information is divided into two sections. Section A contains items which the owner may check without the aid of a service person. Section B contains items which must be performed by qualified service personnel only. If you have any questions other than the ones listed in your troubleshooting guide, contact your distributor.

(NOTE; All units are not the same, therefore some of the causes may not apply to your unit.)

GENERAL TROUBLESHOOTING (SECTION A)

CAUSE	SOLUTION:
1. Sunlamp does not operate.	
a. No power to the unit.	Check circuit breaker servicing unit.
b. Timer not connected to lounge.	Connect cord from timer to timer receptacle on lounge.
c. Timer not turned on.	Rotate time knob clockwise to activate unit.
d. Canopy not connected to lounge	Connect jumper cord from canopy to lounge.
e. "On-off" switch turned off.	Push switch to "on" position.
2. Lamps will not light.	
a. Lamp(s) not properly seated.	Remove lamp(s), inspect contacts on lamp(s), and lampholder(s), reinstall securely into lampholder(s).
b. Faulty lamp(s).	Replace.
3. Canopy does not hold its position when set.	
a. Loose brakes.	Tighten brakes with allen wrench.
b. Faulty cylinders.	Replace.
4. Unit is running hot.	
a. Tanning room too small or improperly ventilated.	Provide sufficient space and ventilation for system.
b. Vent fans dirty.	Clean fan guards to insure air flow is not blocked.
5. Sunlamp is not tanning.	
a. Acrylic is dirty.	Clean both sides of acrylic with U.V.T. (Ultraviolet Transmitting) Acrylic Cleaner.
b. Lamps and Reflectors are dirty.	Remove lamps, wipe with damp cloth, dry. Wipe reflectors using a soft cloth and U.V.T. Cleaner.
c. Lamps are nearing the end of their effective life.	Replace lamps with new lamps.

GENERAL TROUBLE SHOOTING GUIDE (SECTION B)

All services in the following sections are to be completed by a qualified service technician. This section is to aid in isolating and correcting any problems which may occur and is not intended for use by owner. Refer to the assembly instructions included with each bed for guidance in disassembling and wiring the sunlamp. Disconnect all power to the bed before servicing. Use only factory authorized components for replacement parts.

CAUSE

SOLUTION:

1. Sunlamp does not operate.
 - a. Incorrect connections of incoming power.

Check electrical connections against wiring diagram and correct as necessary.
 - b. Faulty timer.

Replace.
 - c. Faulty contactor in bed.

Replace.
 - d. Poor wiring connections.

Check wiring circuit against appropriate wiring diagram and correct as required.
 - e. Power between lounge and canopy not wired correctly.

Check jumper cord connections against diagram and correct as required.
2. Lamp(s) will not light.
 - a. Poor wire connection at lampholder(s).

Check for loose wire(s) and repair.
 - b. Faulty or damaged lampholder(s).

Replace.
 - c. Incorrect incoming power.

Check incoming voltage and correct as required.
 - d. Ballast(s) not functioning properly.

Locate loose wire (to or from) ballast(s) and correct as required. Replace ballast(s) if necessary.
3. Sunlamp running hot.
 - a. Incorrect incoming power.

Check incoming voltage and correct as required.
 - b. Vent fan(s) not functioning properly.

Check wiring to fans and correct as required. Replace vent fan(s) if necessary.
4. Sunlamp is not tanning.
 - a. Incorrect incoming power.

Check incoming voltage and correct as required. Also see **CARE AND CLEANING** section.
5. Sunlamp will not shut off.
 - a. Faulty contactor.

Replace. (Note: return defective contactor to your distributor).
 - b. Faulty timer.

Replace. (Note: return defective timer to your distributor).

PART NO.	DESCRIPTION	QTY.	DWG. NO.
A-03898-1	HARDWARE KIT - CANOPY		
01138	PLASTIC BAG, 5" x 6" x 3 MIL	1	A-01132
A-03073-2	BOLT, 3/8-16 x 2-1/4" HHMB	6	A-03073
A-03073-6	BOLT, 5/16-18 x 1" HHCS	2	A-03073
A-03110-1	PLASTIC BOLT CAP (CAPPLUGS)	6	A-03110
A-03110-2	BOLT CAP WASHER (CAPPLUGS)	6	A-03110
A-04819-1	PLASTIC TUBING CAP	4	A-04819
A-03024-1	SPACER WASHER	4	A-03024
A-04224-1	TEFLON WASHER	2	A-04224
A-03282-1	5/16-18 ELASTIC STOP NUT	2	A-03282
A-03145-1	ALLEN WRENCH - (5/32)	1	A-03145

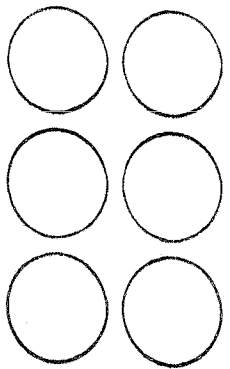
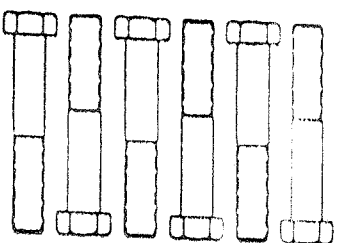
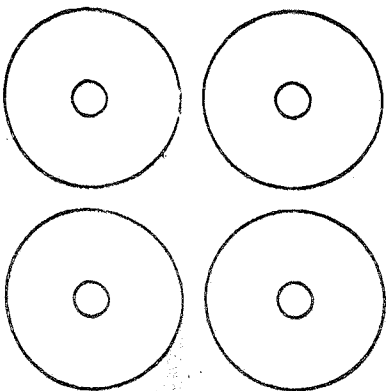
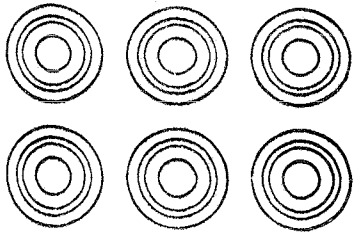
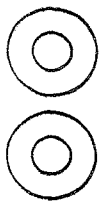
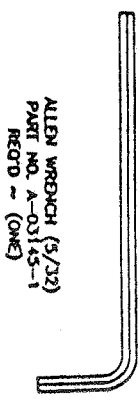

PART NO. A-04223-1
(HARDWARE TO BE PLACED
IN PLASTIC BAG
PART NO. 01138)

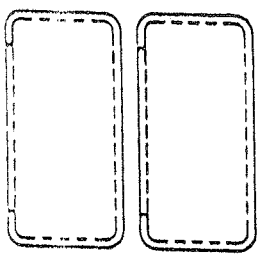
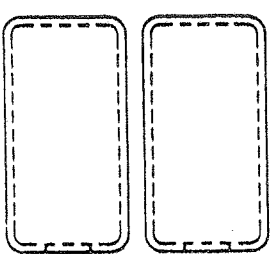

REV	DATE	BY	CHKD	DESCRIPTION
1	12/10/91	JH	AS	REVISION ON CUB. NO. 01138
2	12/10/91	JH	AS	

MONTROSE

HARDWARE KIT - HINGES - MR -
AS SPECIFIED
DATE: 12/10/91
BY: JH
CHKD: AS
PART NO. A-04223-1

REPLACEMENT PARTS LIST

PARTS DESCRIPTION	MONTEGO BAY PART #	MB-2600BX (QUANTITY)	MB-3200BX (QUANTITY)
Acrylic Sheet	B-04689-1	2	0
Acrylic Sheet	B-04690-1	0	2
Allen Wrench - Hinges	A-03145-1	1	1
Ballast (1000 MA Plug-In)	200064	13	16
Body Fan	B-03050-1-1/200169	1	1
Body Fan Rheostat	A-03056-1	1	1
Body Fan Ass'y	300047	1	1
Bolt Cap - Plastic	A-03110-1	6	6
Bolt Cap Washer	A-03110-2	6	6
Brake Boss	A-04696-1	2	2
Brake Shoe	A-03018-1	2	2
Bulb Holder - Fixed	100137-1	26	32
Bulb Holder (Movable)	100138-1	26	32
Contactora	200065	1	1
Cushion	B-04126-1	1	0
Cushion	B-04127-1	0	1
Fuse (AGC-3)	A-03065-1	1	1
Fuse Holder	A-03064-1	1	1
Hardware Kit - Hinges	A-04223-1	1	1
Hardware Kit - Legs	100139	1	1
Hinge Brkt Ass'y - Left	B-04173-3-P	0	1
Hinge Brkt Ass'y - Left	B-04192-3-P	1	0
Hinge Brkt Ass'y - Right	B-04173-3-P	0	1
Hinge Brkt Ass'y - Right	B-04192-2-P	1	0
Hinge Package	B-04225-3	1	0
Hinge Package	B-04225-4	0	1
Hour Meter	A-03067-1	1	1
Jumper Cord Ass'y	200059	1	1
Lamp-SunMaster Plus	100069	26	32
Leg End	200080-1-V	2	0
Leg End	200080-2-V	2	0
Leg End	200080-3-V	0	2
Leg End	200080-4-V	0	2
Leg Side	200081-1-P	4	0
Leg Side	200081-2-P	0	4
"On-Off" Switch	100197	1	1
Pneumatic Cylinder	B-04216-6	2	0
Pneumatic Cylinder	B-04216-5	0	2
Protective Eyewear	A-03134-1	1	1
Remote Timer Ass'y-10 Min.	B-04215-2	1	1
Screw Cap - Plastic	A-03120-1	85	106
Screw Cap - Washer	A-03120-2	85	106
Screw Cap - Plastic (Vent Fans)	A-03120-3	32	48
Screw Cap - Washer (Vent Fans)	A-03120-5	32	48
Screw Cap - Plastic (Legs)	A-03120-3	8	8
Screw Cap - Washer (Legs)	A-03120-4	8	8
Skirt	B-04206-1-V	1	1
Spacer Washer - Hinges	A-03024-1	4	4
Strain Relief	A-03066-1	1	1
Strain Relief Nut	A-03066-2	1	1
Timer/Rheostat Knob	200127-1-P	1	1
Timer-10 Min.	A-03052-3	1	1
Top Panel	200127-P	1	0
Top Panel	200128-P	0	1
Vent Fan	B-03051-1	9	13
Vent Fan Delay	A-04279-1	1	1

